

**ICOM**

**INSTRUCTION MANUAL**

**WIDEBAND RECEIVER**

**IC-R7100**



**Icom Inc.**

## IMPORTANT

**READ THIS INSTRUCTION MANUAL CAREFULLY** before attempting to operate the receiver.

**SAVE THIS INSTRUCTION MANUAL.** This instruction manual contains important safety and operating instructions for the IC-R7100.

## EXPLICIT DEFINITIONS

Word	Definition
<b>⚠ WARNING</b>	Personal injury, fire hazard or electric shock may occur.
<b>CAUTION</b>	Equipment damage may occur.
<b>NOTE</b>	If disregarded, inconvenience only. No personal injury, risk of fire or electric shock.

## PRECAUTIONS

**⚠ DISCONNECT** the AC power cable from the receiver, and wait for a few minutes before performing AC fuse replacement or any internal work.

**⚠ NEVER** apply AC voltage that exceeds the suggested voltage for each version. This could cause a fire or ruin the receiver.

**⚠ NEVER** use non-rated fuses. Non-rated fuses could cause a fire or ruin the receiver.

**⚠ NEVER** let metal, wire or other objects touch any internal parts.

**⚠ NEVER** expose the receiver to rain, snow or any liquids.

**⚠ NEVER** allow children to touch the receiver.

**AVOID** using or placing the receiver in areas with temperatures below  $-10^{\circ}\text{C}$  ( $+14^{\circ}\text{F}$ ) or above  $+60^{\circ}\text{C}$  ( $+140^{\circ}\text{F}$ ).

**AVOID** placing the receiver in excessively dusty environments or in direct sunlight.

**AVOID** placing the receiver against walls or putting anything on top of the receiver. This will obstruct heat dissipation.

**RESPECT** other peoples privacy. Information overhead but not intended for you cannot lawfully be used in any way.

## UNPACKING

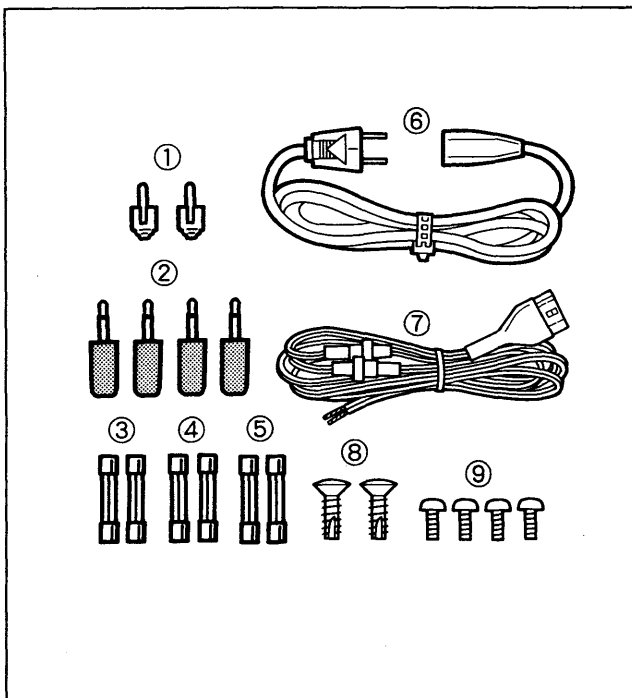

Accessories included with the IC-R7100: Qty.

① RCA plugs .....	2
② Mini plugs (3.5 <sup>o</sup> ) .....	4
③ Spare fuses for DC power cable (FGB 3 A)* <sup>1</sup> ....	2
④ Spare fuses for AC power input* <sup>2</sup> .....	2
⑤ Spare fuses for regulator circuit (FGB 2 A) .....	2
⑥ AC power cable* <sup>3</sup> .....	1
⑦ DC power cable (OPC-023C)* <sup>1</sup> .....	1
⑧ 4 × 12 mm self-tapping screws* <sup>4</sup> .....	2
⑨ 3 × 6 mm self-tapping screws* <sup>4</sup> .....	4

\*<sup>1</sup> Except for AC type Germany version

\*<sup>2</sup> AC type : FGB 1 A (U.S.A., U.S.A.-1 versions)  
 FGB 0.5 A (Europe, France, Australia versions)  
 FGMT4 0.5 A (Germany version)

\*<sup>3</sup> AC type : OPC-034 (U.S.A., U.S.A.-1 versions)  
 OPC-492 (Europe, Germany, France versions)  
 OPC-085 (Australia version)

\*<sup>4</sup> For optional MB-23 installation.

---

# TABLE OF CONTENTS

---

<b>IMPORTANT</b> .....	i	<b>5 SCANS</b> .....	19 ~ 28
<b>EXPLICIT DEFINITIONS</b> .....	i	■ Basic scan .....	19
<b>PRECAUTIONS</b> .....	i	■ Advanced scan .....	20
<b>UNPACKING</b> .....	i	■ Skip function .....	21
<b>TABLE OF CONTENTS</b> .....	ii	■ Voice scan control function .....	21
<b>1 CONTROL FUNCTIONS</b> .....	1 ~ 6	■ Scan resume condition .....	22
■ Front panel .....	1	■ Scan SET mode .....	22
■ Function display .....	5	■ Basic scan operation .....	23
■ Rear panel.....	6	■ Advanced scan operation .....	25
<b>2 CONNECTIONS</b> .....	7 ~ 10	■ Dual scan operation .....	28
■ Unpacking .....	7	<b>6 CLOCK AND TIMER</b> .....	29 ~ 32
■ Mounting the receiver .....	7	■ Clock and timer mode .....	29
■ Antenna .....	7	■ Clock adjustment .....	30
■ Grounding .....	7	■ Timer programming .....	31
■ Connections chart .....	8	■ Timer operation .....	32
■ Power supply connections .....	8	<b>7 MAINTENANCE AND ADJUSTMENT</b> .....	33 ~ 36
■ Tape recorder connections .....	9	■ Disassembling .....	33
■ Remote jack (CI-V) information .....	10	■ CPU resetting .....	33
<b>3 BASIC OPERATIONS</b> .....	11 ~ 14	■ Fuse replacement .....	34
■ Initial settings .....	11	■ AC voltage modifications .....	34
■ Tuning step setting .....	11	■ Backup batteries .....	35
■ Frequency setting .....	12	■ Beep tone ON/OFF .....	35
■ Receiving .....	13	■ Main dial brake adjustment .....	35
<b>4 MEMORY CHANNELS</b> .....	15 ~ 18	■ Cleaning .....	35
■ Memory channel description .....	15	■ Troubleshooting .....	36
■ Memory channel selection .....	16	<b>8 OPTION INSTALLATIONS</b> .....	37
■ Memory writing .....	17	■ UT-36 VOICE SYNTHESIZER UNIT .....	37
■ Contents clearing .....	18	■ MB-23 CARRYING HANDLE .....	37
■ Searching for memory channels programmed with the same frequency .....	18	<b>9 INSIDE VIEWS</b> .....	38
■ Window .....	18	■ Under the top cover .....	38
		■ Under the REG unit .....	38
		■ Under the bottom cover .....	38
		<b>10 SPECIFICATIONS</b> .....	39
		<b>11 OPTIONS</b> .....	40
		<b>SCHEMATIC DIAGRAM</b> .....	SEPARATE

# 1 CONTROL FUNCTIONS

## Front panel

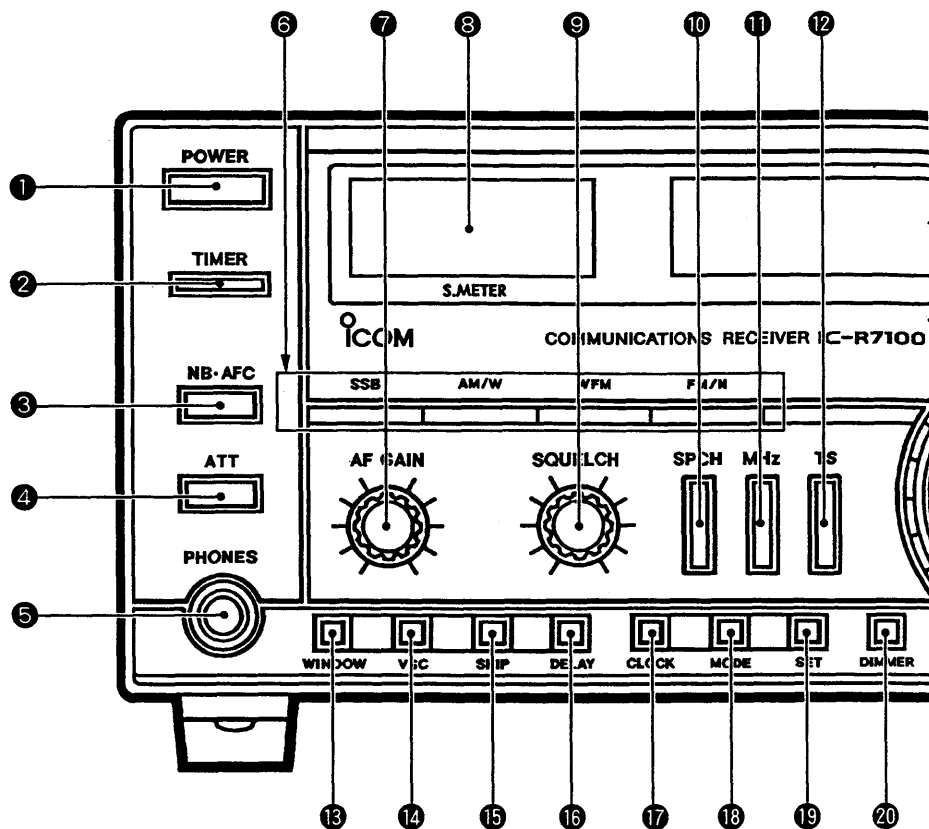

**① POWER SWITCH [POWER]**  
Turns the power ON and OFF.

**② TIMER SWITCH [TIMER]** (p. 32)  
Activates the timer function.

**③ NOISE BLANKER/AFC SWITCH [NB-AFC]**  
(p. 14)  
- Activates the noise blanker circuit in SSB (LSB, USB) and AM (or AM-W) modes.  
• "NB" appears.  
- Activates the automatic frequency control function in FM (or FM-N) and WFM mode.  
• "AFC" appears.

**④ ATTENUATOR SWITCH [ATT]** (p. 14)  
Activates the RF attenuator function.

**⑤ HEADPHONE JACK [PHONES]**  
Accepts a headphone connection.  
• Headphones with 4 ~ 16  $\Omega$  impedance can be used.  
• When headphones are connected, the internal speaker does not function.

**⑥ MODE SWITCHES** (p. 14)  
Select the desired receiving mode.  
• The selected mode is indicated.

**⑦ AF GAIN CONTROL [AF GAIN]** (p. 13)  
Varies the audio output level.  
• The audio level of the beep is automatically shifted depending on the value of the audio output level.

**⑧ S-METER [S.METER]**  
- Shows the strength of the receiving signal.  
- Shows the S-meter squelch threshold level.

**⑨ SQUELCH CONTROL [SQUELCH]** (p. 13)  
Varies the squelch threshold level.

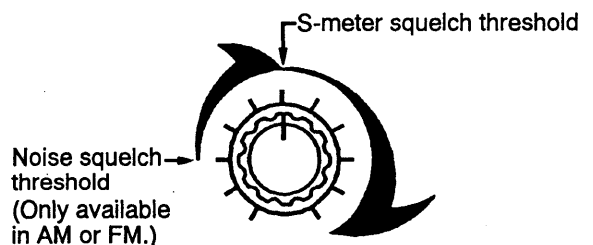

**⑩ SPEECH SWITCH [SPCH]**  
Announces the displayed frequencies in English or Japanese when an optional UT-36 VOICE SYNTHESIZER UNIT is installed.

**⑪ MHz TUNING STEP SWITCH [MHz]** (p. 11)  
Sets the tuning step of the main dial in MHz steps.  
• "▼" appears on the MHz digit.

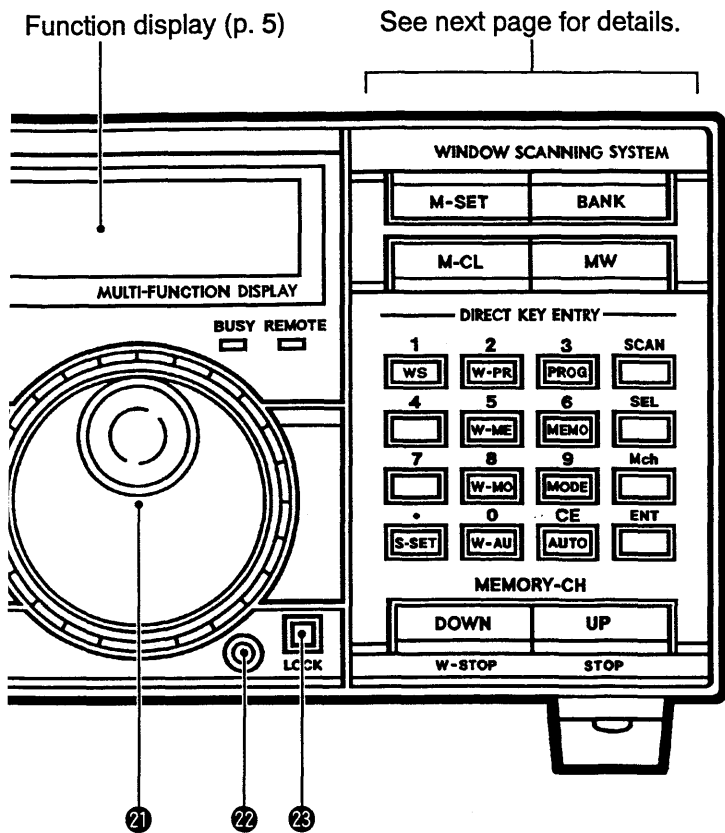
**12 TUNING STEP SWITCH [TS]** (p. 11)

Selects the tuning step of the main dial.

- 100 Hz, 1 kHz, 5 kHz, 10 kHz, 12.5 kHz, 20 kHz, 25 kHz, and 100 kHz tuning steps are available.

**13 WINDOW SWITCH [WINDOW]** (p. 18)

Changes the window.

**14 VSC SWITCH [VSC]** (p. 21)

Activates the voice scan control function.

- "VSC" appears when the function is activated.

**15 SKIP SWITCH [SKIP]** (p. 21)

Turns the skip function ON and OFF for scanning.

- "SKIP" appears when the function is activated.
- When this function is activated, skip channels or skip frequencies are skipped during scan operation.

**16 DELAY SWITCH [DELAY]** (p. 22)

Selects a scan resume condition.

- "▲" indicates the selected scan resume condition.

**17 CLOCK SWITCH [CLOCK]** (p. 29)

Selects the clock and timer mode.

**18 CLOCK MODE SWITCH [MODE]** (p. 29)

Selects the clock or one of the timers in the clock and timer mode.

**19 CLOCK SET SWITCH [SET]** (p. 29)

- Sets the timers and clock time.

- Turns the selected timer condition ON or OFF.

- Selects the clock and timer setting condition when pushing the switch for 2 sec.

**20 DIMMER SWITCH [DIMMER]**

Changes the brightness of the function display backlighting and of the meter backlighting.

**21 MAIN DIAL**

- Changes the operating frequency and memory channel number.

- Changes the time of the clock and timers.

**22 BRAKE ADJUSTMENT SCREW** (p. 35)

Adjusts the main dial tension.

**23 DIAL LOCK SWITCH [LOCK]** (p. 14)

Locks the main dial electronically.

# 1 CONTROL FUNCTIONS

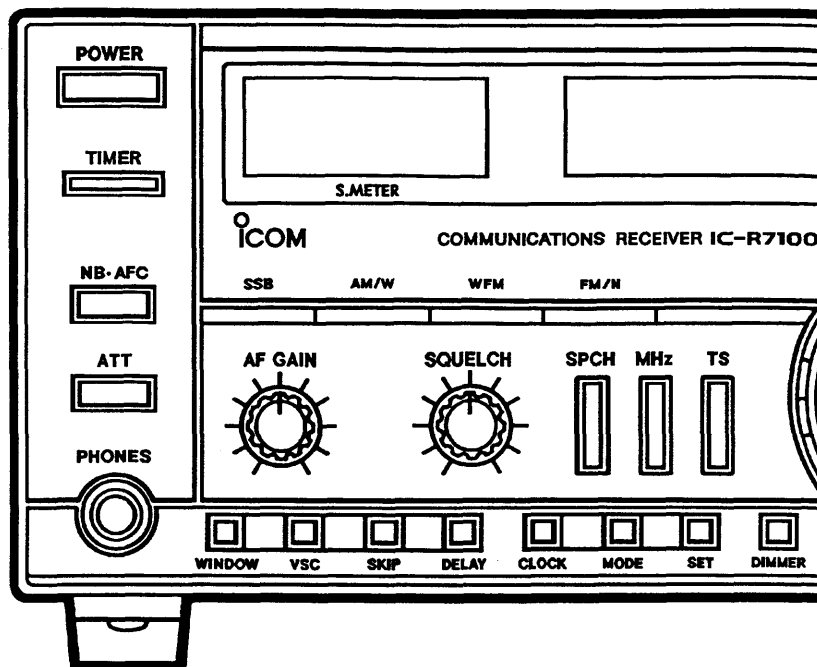

## 24 BUSY INDICATOR [BUSY]

Lights up in green when the squelch is open.

## 25 REMOTE INDICATOR [REMOTE]

Lights up in red while controlling AF gain using the CI-V system.

- The indicator goes off when the [AF GAIN] control is rotated.

## 26 MEMORY CONTENTS CLEAR SWITCH [M-CL] (p. 18)

Clears the contents from the displayed memory channel when pushing the switch for 2 sec.

## 27 MEMORY CHANNEL NUMBER SET SWITCH [M-SET] (p. 18)

Hold the contents on the function display while this switch is pushed.

- While pushing this switch, the memory channel number can be changed with the main dial, [UP]/[DOWN] switches or the keyboard.
- To store the contents after changing the memory channel number, push and hold [MW].

## 28 BANK SWITCH [BANK] (p. 16)

- Selects a bank of memory channels.
  - The hundreds' digit changes in the channel number display.
- Designates a bank when holding the switch for 2 sec.
  - "BANK" appears.
  - Only memory channels in the designated bank can be selected in this condition.

## 29 MEMORY WRITE SWITCH [MW] (p. 17)

Stores the displayed frequency, mode and tuning step in the displayed memory channel when pushing the switch for 2 sec.

## 30 MEMORY CHANNEL DOWN SWITCH [DOWN] (W-STOP) (p. 16)

- Changes the memory channel number downward.
- Stops advanced scans and the window scan.

## 31 MEMORY CHANNEL UP SWITCH [UP](STOP) (p. 16)

- Changes the memory channel number upward.
- Stops all basic scans except for window scan.

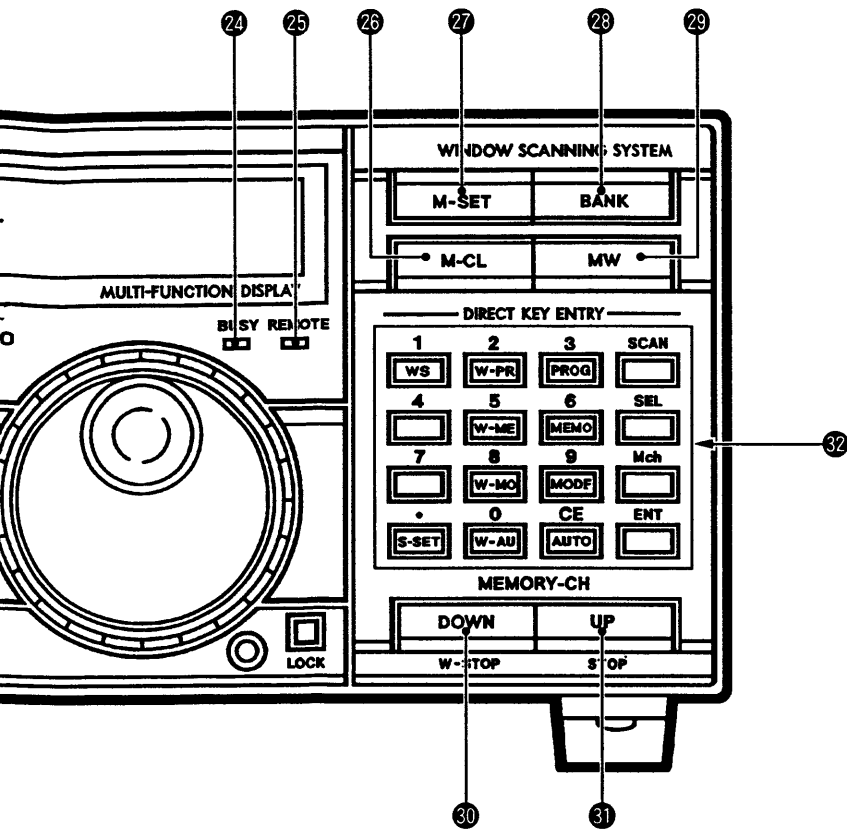

### 32 KEYBOARD

KEY	PRIMARY FUNCTION	SECONDARY FUNCTION (After pushing [SCAN])	REF
1 (WS)	Enters "1."	Starts the window scan.	p. 25
2 (W-PR)	Enters "2."	Starts the window programmed scan.	p. 25
3 (PROG)	Enters "3."	Starts the programmed scan.	p. 23
4	Enters "4."	No function.	
5 (W-ME)	Enters "5."	Starts the window memory scan.	p. 26
6 (MEMO)	Enters "6."	Starts the memory scan.	p. 23
7	Enters "7."	No function.	
8 (W-MO)	Enters "8."	Starts the window selected mode memory scan.	p. 26
9 (MODE)	Enters "9."	Starts the selected mode memory scan.	p. 24
0 (W-AU)	Enters "0."	Starts the window auto memory write scan.	p. 27
• (S-SET)	Enters "•."	Enters the scan set mode.	p. 22
CE (AUTO)	Clears input digits.	Starts the auto memory write scan.	p. 24
SCAN	Selects the scanning function. Activates digit keys for the secondary functions.		
SEL	While pushing this key, the main dial sets the select-number of the memory channel.		p. 15
Mch	- Selects the entered memory channel number. - While pushing this key, the main dial and digit keys select a memory channel number.		p. 16
ENT	Selects the entered frequency.		p. 12

## ■ Function display

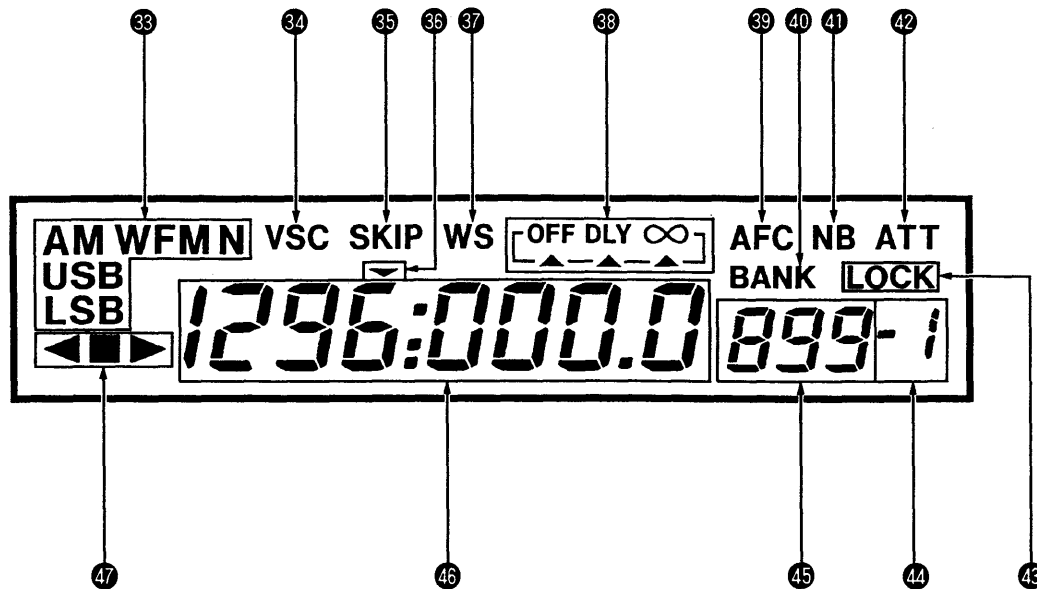

- 33 **MODE INDICATORS** (p. 14)  
Show the operating mode.
- 34 **VSC INDICATOR** (p. 21)  
Appears when the voice scan control function is activated.
- 35 **SKIP INDICATOR** (p. 21)  
Appears when the skip function is activated.
- 36 **MHz TUNING STEP INDICATOR** (p. 11)  
Appears when the MHz tuning step is selected.
- 37 **WINDOW SCAN INDICATOR** (p. 25)  
Appears when the window scan is activated.
- 38 **SCAN RESUME CONDITION INDICATOR** (p. 22)  
Show the selected scan resume condition.
- 39 **AFC INDICATOR** (p. 14)  
Appears when the Automatic Frequency Control function is activated in either WFM or FM mode.
- 40 **MEMORY BANK INDICATOR** (p. 16)  
Appears when the memory bank is defined.
- 41 **NB INDICATOR** (p. 14)  
Appears when the noise blanker circuit is activated.
- 42 **ATT INDICATOR** (p. 14)  
Appears when the RF attenuator is activated.
- 43 **DIAL LOCK INDICATOR** (p. 14)  
Appears when the dial lock function is activated.
- 44 **SELECT-NUMBER READOUT** (p. 15)  
Shows the select-number of the displayed memory channel, if the memory channel contains a select-number. It is used for the memory scan.
- 45 **MEMORY CHANNEL READOUT**  
Shows memory channel numbers.
- 46 **FREQUENCY READOUT**  
- Shows the operating frequency.  
- Shows the clock time when selecting the clock and timer mode.
- 47 **FM CENTER INDICATORS**  
- "■" shows the displayed frequency is at the center of the received signal.  
- "◀" shows the displayed frequency is higher than the received signal.  
- "▶" shows the displayed frequency is lower than the received signal.



## ■ Rear panel

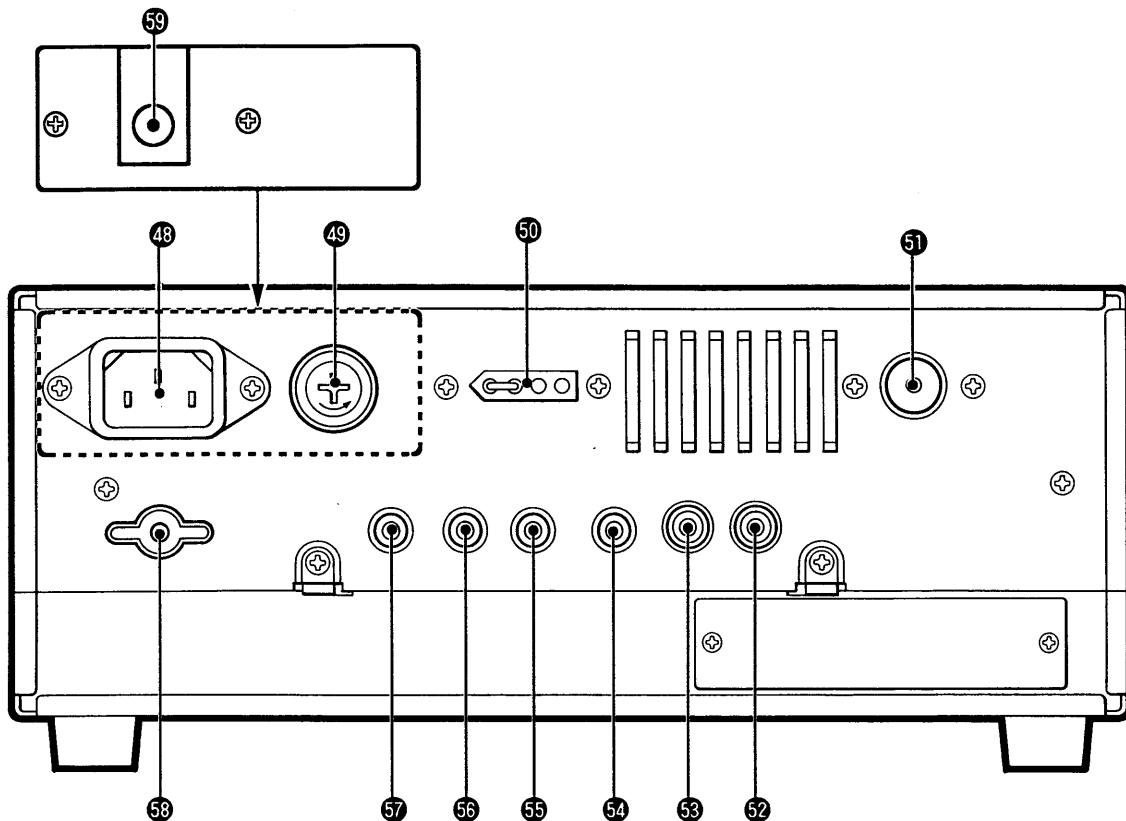

- 48 AC POWER SOCKET [AC]** (p. 8) (AC type only)  
Connects the AC power cable.
- 49 FUSE HOLDER [FUSE]** (p. 34) (AC type only)  
Holds an AC power input fuse for internal AC supply protection.
- 50 DC POWER JACK [DC]** (p. 8)  
(Except for Germany version)  
Connects the supplied DC power cable.  
• For AC power operation, confirm that the supplied jumper cable is connected to [DC].
- 51 ANTENNA CONNECTOR [ANT]** (p. 7)  
Connects a 50  $\Omega$  antenna through a coaxial cable with type-N connector.
- 52 AGC JACK [AGC]** (p. 8)  
Outputs an AGC signal for an optional TV-R7100 TV RECEIVE ADAPTER.  
• This jack can be used as a spare jack. Refer to p. 38 "Under the REG unit" for modification.
- 53 IF OUT JACK [IF OUT]** (p. 8)  
Outputs a 10.7 MHz IF signal with 9 V DC for an optional TV-R7100 TV RECEIVE ADAPTER.
- 54 CI-V REMOTE CONTROL JACK [REMOTE]** (p. 10)  
Connects an optional CT-17 CI-V LEVEL CONVERTER for computer control.
- 55 RECORDER REMOTE JACK [REC REMOTE]** (p. 9)  
Controls the running of a tape recorder for recording. Connects to the REMOTE jack on a tape recorder.
- 56 RECORDER JACK [REC]** (p. 9)  
Outputs an audio signal. Connect to the AUX or LINE IN jack on a tape recorder.
- 57 EXTERNAL SPEAKER JACK [EXT SP]**  
Connects a 4 ~ 8  $\Omega$  external speaker.  
• When an external speaker is connected, the internal speaker does not function.
- 58 GROUND TERMINAL [GND]** (p. 7)  
Connect this terminal to a ground.
- 59 AC ADAPTER JACK [AC ADAPTER]** (p. 8) (DC type only)  
Connects an optional AD-55 AC ADAPTER.

# 2 CONNECTIONS

## ■ Unpacking

After unpacking, immediately report any damage to the delivering carrier or your Icom Dealer. Save the shipping cartons. Refer to p. i "UNPACKING" for accessory supplied with the IC-R7100.

## ■ Mounting the receiver

### • For base operation

Select a location which:

- allows adequate air circulation.
- provides access to the front and rear panels.
- is free from extreme heat, cold, or vibrations.
- is away from TV sets, radios and electromagnetic sources.

### ADJUSTABLE ANGLES

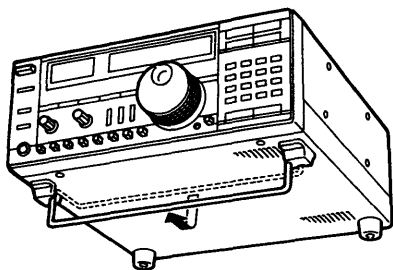

The stand on the bottom gives the receiver two selectable angles.

### • For mobile operation

Mount the receiver using an optional IC-MB5 MOBILE MOUNTING BRACKET. Select a location which:

- can support the weight of the receiver.
- does not interfere with the operation of the vehicle.
- does not interfere with air bag operation.

## ■ Antenna

Antennas play a very important role in receiver operation. Use a 50  $\Omega$  wideband antenna such as a discone or log-periodic antenna. When the receive band is already determined, use an antenna that is matched to the band.

Coaxial cable is important especially for HF band receiving. Use thick coaxial cable. Make the coaxial cable length as short as possible.

## ■ Grounding

**WARNING:** NEVER use a gas pipe or electrical conduit pipe for grounding.

To prevent accidents involving electricity and interference from transceivers, ground the receiver through the [GND] terminal on the rear panel.

For best results, connect a heavy gauge cable to a water pipe or long earth-sunk copper rod. Make the distance between the [GND] terminal and ground as short as possible.

### TYPE-N CONNECTOR INSTALLATION

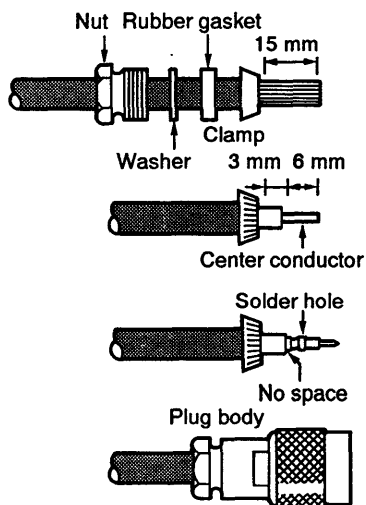

1) Slide the nut, rubber gasket and clamp over the coaxial cable. Then cut the end of the cable evenly.

2) Strip the cable and fold the braid back over the clamp.

3) Soft solder the center conductor. Install the center conductor pin and solder it.

4) Carefully slide the plug body into place aligning the center conductor pin on the cable. Tighten the nut onto the plug body.

- Be sure the center conductor is the same height as the plug body.

## Connections chart

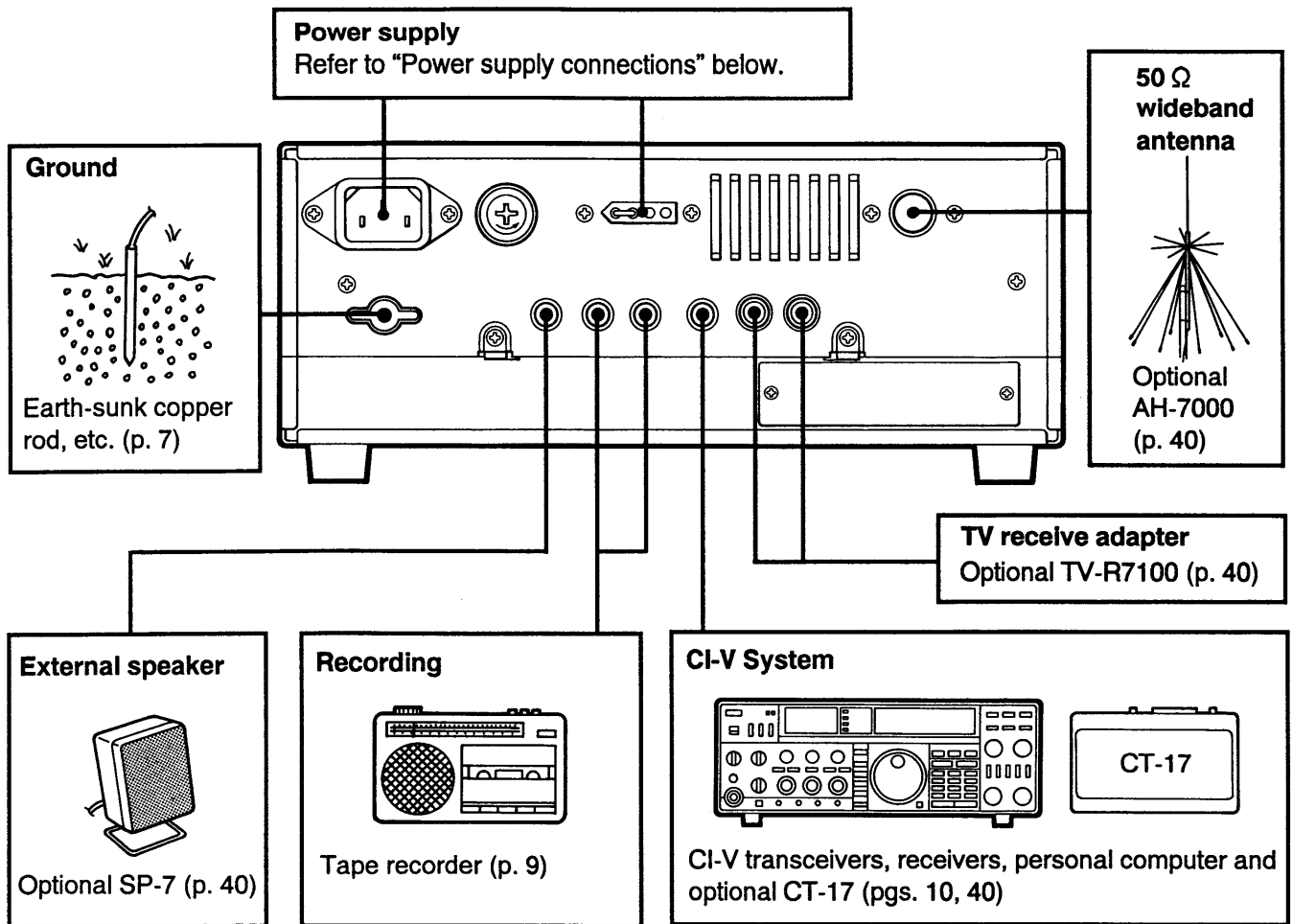

## Power supply connections

**AC operation for AC type**

Confirm that the jumper connector is connected to [DC] in advance.

Connect to an AC outlet using the supplied AC power cable.

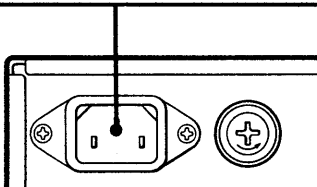

**DC operation for both AC and DC types (except for Germany)**

Disconnect the jumper connector from [DC] in advance.

Connect to 12 V DC power source using the supplied DC power cable.  
Red : positive ⊕ terminal  
Black : negative ⊖ terminal

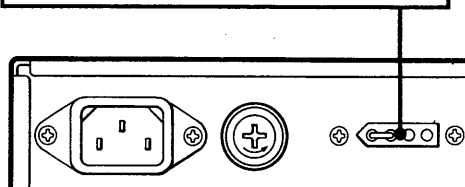

**AC operation for DC type**

Connect an optional AD-55 to [AC ADAPTER].

The AD-55 outputs non-regulated 16 V DC.

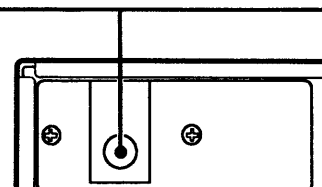

## ■ Tape recorder connections

You can record received signals with your tape recorder through the [REC] jack in the two ways. The audio output level is fixed for the AUX jack of a tape recorder, regardless of the [AF GAIN] position.

### • Manual recording

Tape recorder must be turned ON and OFF manually to record the received signal.

Connect a cable between the AUX jack on your tape recorder and [REC] on the IC-R7100 rear panel.

### • Automatic recording

The receiver controls tape recorder running through the [REC REMOTE] jack. The tape recorder runs only when the squelch opens.

Use of the timer function enables even greater control of recording when you are away from the receiver.

Connect cables from the AUX and REMOTE jacks on your tape recorder to the [REC] and [REC REMOTE] jacks on the IC-R7100 rear panel.

**NOTE:** Check audio level, connections, etc. before setting the transceiver for automatic recording.

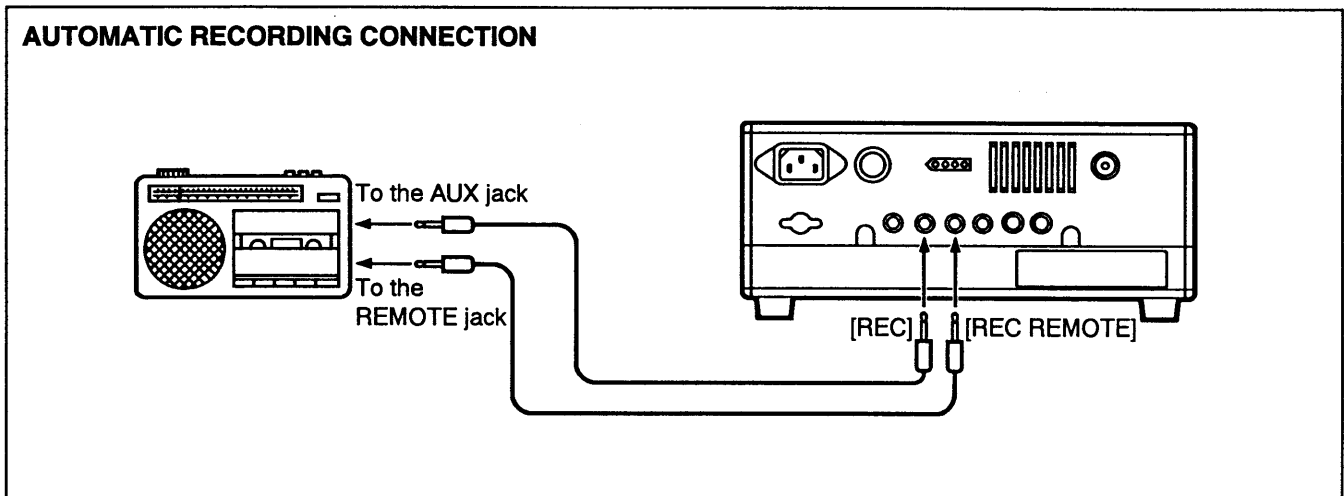
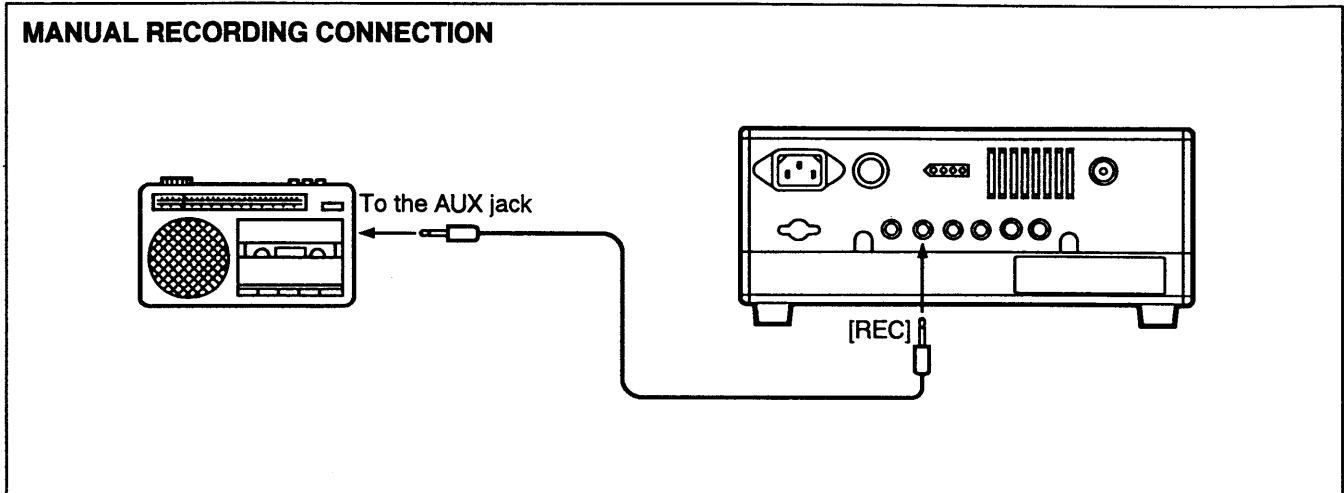

## Remote jack (CI-V) information

The IC-R7100 can be connected through an optional CT-17 CI-V LEVEL CONVERTER to a personal computer equipped with an RS-232C port. Icom Communication Interface-V (CI-V) controls frequency, mode, memory channels, etc.

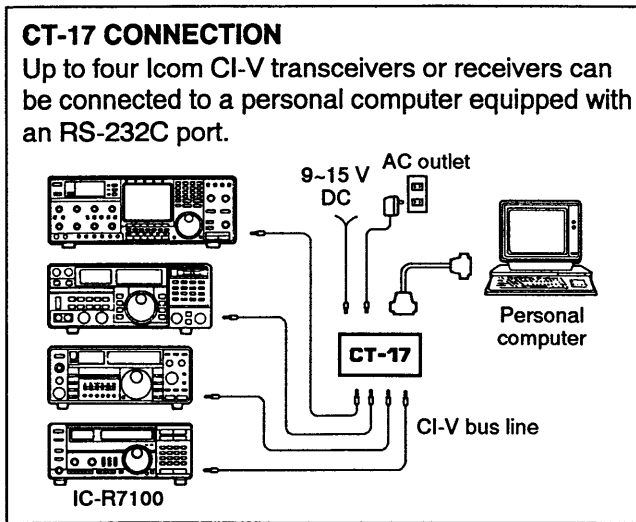

### • Setting the CI-V condition with the diode matrix

Transmitters and receivers using the Icom CI-V system exchange serial information in the packet format. The contents of a data packet can be changed by the diode matrix. Solder the required jumper points to change the diode matrix. See the right figure for the location of the soldering point.

### BAUD RATE

Baud rate is the data transfer rate. The standard Icom CI-V baud rate is 1200 bps.

BAUD RATE (bps)	JUMPER POINTS	
	B0	B1
9600	Open	Open
4800	Short	Open
<b>1200</b>	<b>Open</b>	<b>Short</b>
300	Short	Short

: Default

### FREQUENCY DATA

When connecting the receiver with the IC-735, change the frequency data to 4 bytes.

FREQUENCY DATA	JUMPER POINT (731)
4 bytes	Short
<b>5 bytes</b>	<b>Open</b>

: Default

### ADDRESS

You can designate an address for your IC-R7100. The IC-R7100 has the address of 34H (52) as a default value preset at the factory.

Figures marked with an H are hexadecimals and bracketed figures ( ) are decimals.

JUMPER POINTS							
A0 (1)	A1 (2)	A2 (4)	A3 (8)	A4 (16)	A5 (32)	A6 (64)	A7 (128)
Open	Open	Short	Open	Short	Short	Open	Open

: Default

### TRANSCIVE

Transceive operation is possible on the IC-R7100 with an Icom station transceiver such as an IC-970.

TRANSCIVE	JUMPER POINT
ON	Short
OFF	Open

: Default

### JUMPER POINT LOCATION (LOGIC board)

See p. 38 for the location.

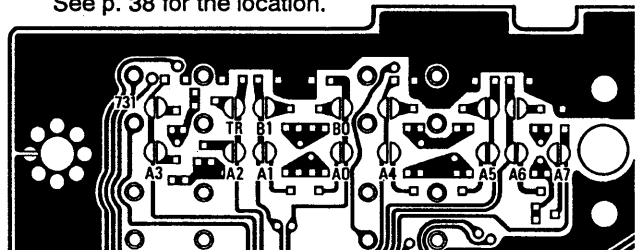

### • Setting a CI-V condition via the keyboard

Via the keyboard of the IC-R7100 you can change the transceive function and baud rate in the same way as functions are changed via the diode matrix.

- 1) Turn OFF the receiver power.
- 2) While pushing the following keys, turn power ON.

CONDITION	KEY
Transceive OFF	ENT + 2
Transceive ON	ENT + 3
Transceive ON for IC-735	ENT + 4
Baud rate 9600	ENT + 5
Baud rate 4800	ENT + 6
Baud rate 1200	ENT + 7
Baud rate 300	ENT + 8
Returns to the matrix setting	ENT + 1

## Initial settings

**NOTE:** Follow all instructions in Section 2, "CONNECTIONS" before operating the receiver.

- 1) Be sure [POWER] is OFF. Connect the AC power cable or AC adapter to an AC outlet.
- 2) Be sure an antenna is securely connected to the antenna connectors.
- 3) Be sure the receiver is grounded through the [GND] terminal.
- 4) Be sure of external equipment connections, if any.
- 5) Set switches and controls as shown in the table below.
- 6) Turn power ON.
  - Push IN the [POWER] switch.

SWITCH	POSITION
POWER	OFF (OUT)
TIMER	OFF (OUT)

CONTROL	POSITION
AF GAIN	Fully CCW
SQUELCH	Fully CCW

CCW: Counterclockwise

[POWER] [TIMER]

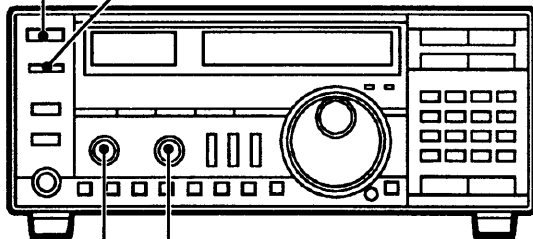

[AF GAIN] [SQUELCH]

## Tuning step setting

8 tuning steps and 1 MHz step are available.

### 1 MHz STEP SETTING

Push [MHz] to select the 1 MHz step.

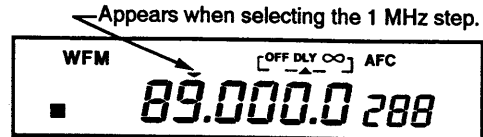

### SELECTING OTHER TUNING STEPS

- 1) Push [TS].
- 2) Rotate the main dial to select a tuning step.
  - 100 Hz, 1, 5, 10, 12.5, 20, 25 or 100 kHz steps are available.
- 3) Push [TS] again.
  - Operating frequency reappears and can be set with the selected tuning step.

### [EXAMPLE] SELECTING THE 12.5 kHz TUNING STEP.



Push 

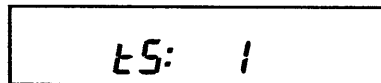

Rotate  to select 12.5.

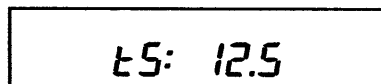

Push 



Now the 12.5 kHz tuning step is set.

## Frequency setting

There are 2 ways to set a frequency: with the main dial or the keyboard.

**NOTE:** Unless the displayed frequency is written into the displayed memory channel, it disappears when the memory channel is changed.

### Using the main dial

- 1) Push [MHz] to illuminate the MHz step indicator for the MHz digit setting.
  - When "LOCK" appears on the function display, push [LOCK] to deactivate the dial lock function.
- 2) Rotate the main dial to change the MHz digit.
  - To change the tuning step of the main dial, see p. 11.
- 3) Push [MHz] to turn OFF the MHz step indicator.
- 4) Rotate the main dial to set the desired frequency.

### Using the keyboard

- 1) Push keyboard numeral keys to enter the MHz digits for frequencies in the 25 ~ 1999 MHz range.
  - If a wrong number is entered, push [CE] and start again from the beginning.
  - When entering the same MHz digits as the frequency that is shown on the function display, skip this section.
- 2) Push [•].
- 3) Push numeral keys to enter frequency digits below 1 MHz.
  - When entering a wrong number, push [CE] and start from the beginning.
- 4) Push [ENT] to input the entered frequency.
  - When pushing [ENT] after entering MHz digits, zeros are automatically entered as the kHz digits.

145

### SETTING A FREQUENCY AT 145.000 MHz USING THE KEYBOARD.

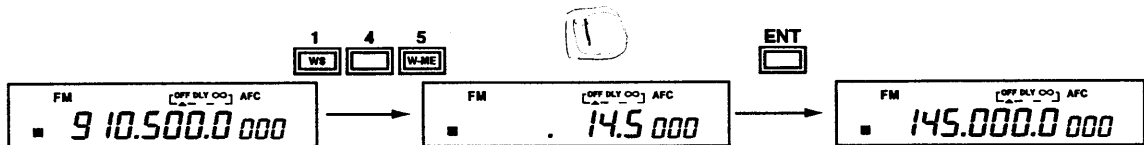

### SETTING A FREQUENCY AT 1296.04 MHz USING THE KEYBOARD.

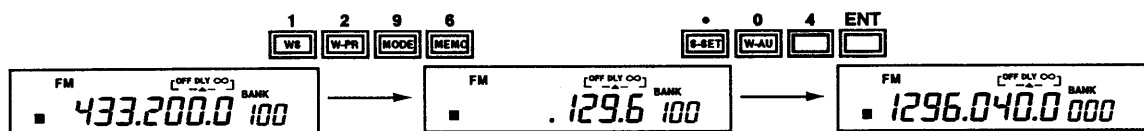

### CHANGING A FREQUENCY FROM 28.495 MHz TO 50.110 MHz USING THE MAIN DIAL.

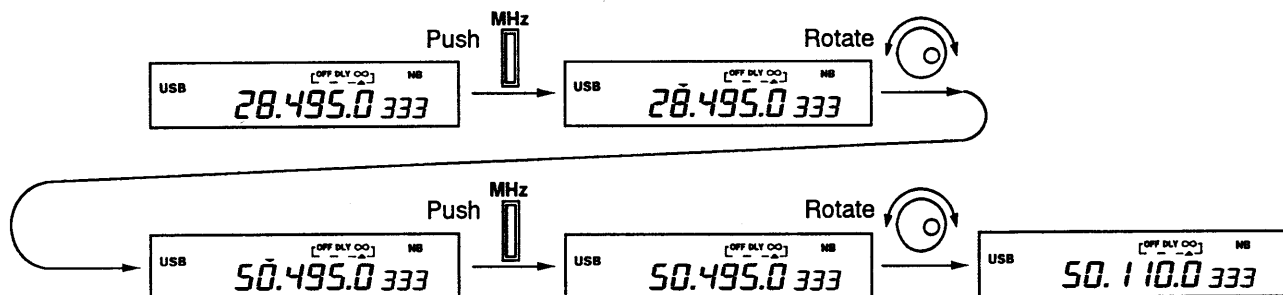

**NOTE:** When the AFC function is activated, the displayed frequency may automatically move to the center of the received signal in FM and WFM mode.

- When "◀" appears, the frequency moves downward.
- When "▶" appears, the frequency moves upward.
- When "■" appears, the frequency does not move.

### 3 BASIC OPERATIONS

## Receiving

- 1) Set switches and controls as described on p. 11.
- 2) Push [POWER] IN to turn power ON.
- 3) Push a MODE switch one or twice to set the desired operating mode.
  - Each push of [AM/W] alternately selects "AM" and "AM W."
  - Each push of [FM/N] alternately selects "FM" and "FM N."
  - Each push of [SSB] alternately selects "USB" and "LSB."
- 4) Set [SQUELCH] to the max. counterclockwise position.
- 5) Adjust [AF GAIN] to the desired audio output level.
- 6) Set the desired receive frequency using the keyboard or the main dial. See p. 12 for details.
- 7) Rotate [SQUELCH] clockwise if you want to mute the audio noise.
  - The IC-R7100 has 2 types of squelches, noise squelch and S-meter squelch. See p. 14 for details.

- Fine tuning with the main dial

#### SSB AND AM MODES

Set the frequency to the point where you can hear the signal clearly.

#### WFM AND FM MODES

Set the frequency to the point where the "■" center indicator is displayed.

**NOTE:** When the AFC function is activated, the displayed frequency may automatically move to the center of the received signal in FM or WFM mode.

#### [NB•AFC]

Push IN to activate the noise blanker circuit or automatic frequency control function. (p. 14)

- The noise blanker circuit can be activated in SSB and AM modes.
- The AFC (Automatic Frequency Control) function can be activated in WFM and FM modes.

#### [MODE]

Push the desired mode switch. (p. 14)

- [SSB] selects USB or LSB alternately.
- [AM/W] selects normal AM or AM-wide alternately.
- [FM/N] selects normal FM or FM-narrow alternately.

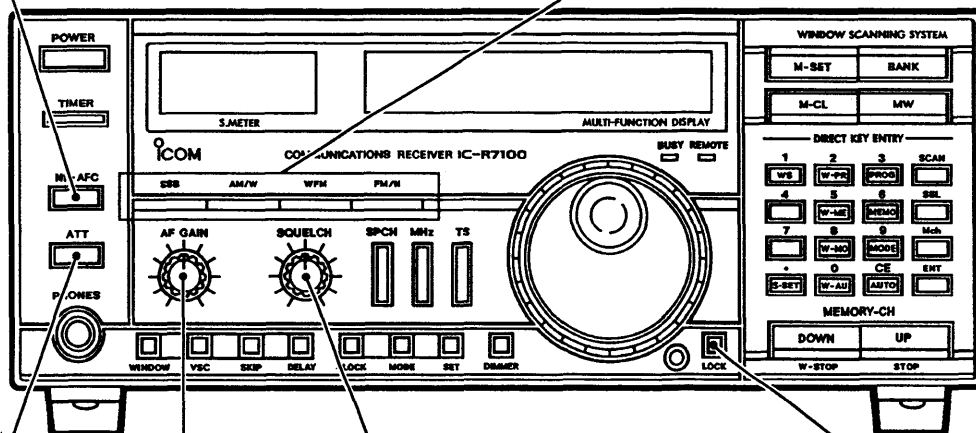

#### [ATT]

Push to activate the attenuator circuit. (p. 14)

#### [AF GAIN] [SQUELCH]

#### [LOCK]

Push to activate the dial lock function. (p. 14)



• **Mode selection**

MODE	SELECTION	COMMUNICATIONS EXAMPLE	NOTE
<b>AM</b> (AM, AM W)	The [AM] switch selects normal AM and AM-wide alternately.	Broadcasting, amateur bands, citizens band, air band, etc.	AM-wide mode is used for clear audio reception. Signals, however, may be received with interference.
<b>SSB</b> (USB, LSB)	The [SSB] switch selects USB and LSB alternately.	HF broadcasting, amateur bands, etc.	Use USB for normal SSB reception. LSB is not used for normal use. For CW reception, use USB or LSB.
<b>WFM</b>	The [WFM] switch selects WFM.	TV broadcasting, FM broadcasting, etc.	TV and FM broadcasting cannot be accessed in FM mode because their signal is too wide.
<b>FM</b> (FM, FM N)	The [FM] switch selects normal FM and FM-narrow alternately.	Amateur bands, citizens band, utility communication, marine bands, etc.	FM-narrow can only receive narrow FM signals. Normal FM mode can receive both normal and narrow FM signals.

• **NB (Noise Blanker) function**  
(Only in SSB and AM modes)

The noise blanker effectively reduces interference from pulse-type noise such as car ignition systems.

- 1) Push [NB•AFC] in SSB or AM mode.
  - “NB” appears.
- 2) To cancel the function, push [NB•AFC] again.
  - “NB” disappears.

• **AFC (Automatic Frequency Control) function**  
(Only in WFM or FM mode)

The automatic frequency control function catches up with the received signals when the signal moves.

- If this function is activated, the displayed frequency moves to the center point automatically without rotating the main dial.

- 1) Push [NB•AFC] in WFM or FM mode.
  - “AFC” appears.
- 2) To cancel the function, push [NB•AFC] again.
  - “AFC” disappears.

**NOTE:** AFC automatically moves the receiving frequency to the center of the received signal once you have roughly tuned the receiving frequency.

• **Attenuator circuit**

The attenuator circuit attenuates the signal strength to 20 dB to protect the RF amplifier from distortion when excessively strong signals are received.

- 1) Push [ATT].
  - “ATT” appears.
- 2) To cancel the function, push [ATT] again.
  - “ATT” disappears.

• **Dial lock function**

The dial lock function electronically locks the main dial to prevent accidental frequency changing.

- 1) Push [LOCK].
  - “LOCK” appears.
- 2) To cancel the function, push [LOCK] again.
  - “LOCK” disappears.

**Tech Talk from Icom**  
 You already know that the IC-R7100 has 2 types of squelch:  
 - Noise squelch  
 - S-meter squelch  
**What’s the difference between these two?**

**NOISE SQUELCH**  
 Noise squelch only acts against noise; it has good sensitivity. Therefore, it will open in order to receive a weak signal. Strong signals exceeding a certain level will always cause the squelch to open.

**S-METER SQUELCH**  
 S-meter squelch does not open for weak signals but can be adjusted to open for signals in a wide range of strengths. Once you have selected a threshold point in the range, the IC-R7100 can open for all signals above this point.

**2-SQUELCH COMBINATION**  
 To combine these squelches, the dynamic range between the threshold and tight squelch can be set in a very wide range for AM and FM operation.

# 4 MEMORY CHANNELS

## Memory channel description

The IC-R7100 has 900 memory channels and 20 programmable scan edge channels separate from the memory channels. The 900 memory channels are divided into 9 banks. Each bank has 100 memory channels (X00~X99). Each memory channel stores a frequency, mode, tuning step and skip channel information.

Memory channels can store a select-number. The memory scan function scans only channels with a user-specified select-number.

The IC-R7100 has 20 scan edge channels (0P1~9P2) in addition to the memory channels. They can be used to store the scan edge frequencies, and they form a 10th bank of memory channels.

**NOTE:** When memory channels without information (blank channels) are selected, the frequency is not displayed. Only the memory channel number appears.

### • Front and back window

The IC-R7100 includes 2 windows. Each window has one memory channel on its display. See p. 18 for details.

BANK NUMBER	MEMORY CHANNEL NUMBER	USE
0	0~99	For normal use. Frequency, mode and tuning step are written. Select-number can also be written.
1	100~199	
2	200~299	
3	300~399	
4	400~499	
5	500~599	
6	600~699	
7	700~799	Memorize skip frequencies for programmed scan. Skip information, "S," is written as the select-number.
8	800~899	Memorize frequencies for auto memory write scan. Mode and tuning step are written at the same time.
9	0P1~9P2	Memorize scan edge frequencies. 0P1 and 0P2, 1P1 and 1P2, 2P1 and 2P2, ..., 9P1 and 9P2 are the edge pairs.

### • Select-number

A select-number (1~9) is used for memory scan. Memory channels with the same select-number are scanned during memory scan.

Select-number "S" is skip information for the skip function. To program skip information, select "S" as a select number.

### PROGRAMMING A SELECT-NUMBER

- 1) Select the memory channel which will be programmed with a select-number.
- 2) While pushing [SEL], rotate the main dial to select the desired select-number.
- 3) Release [SEL] to program the select-number.
- 4) To erase the select-number, push [SEL] again.

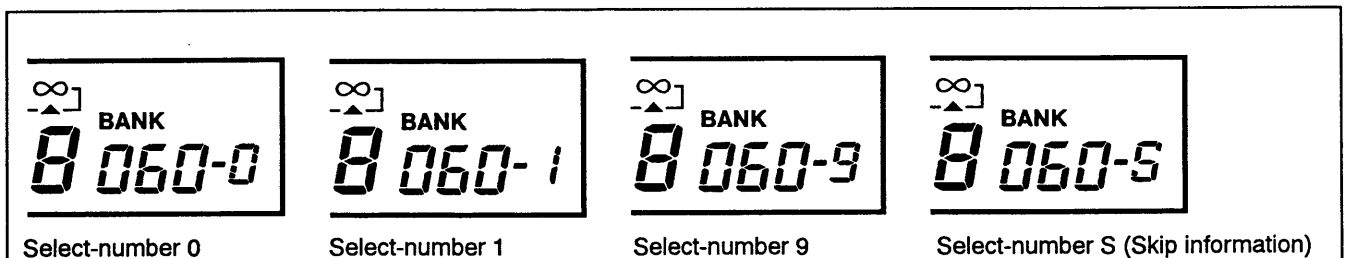

## Memory channel selection

There are three ways to select the desired memory channel:

- Using the [UP]/[DOWN] switches
- Using the keyboard
- Using the main dial

### MEMORY BANK DESIGNATION

Once a memory bank is designated, the [UP]/[DOWN] switches and main dial can only be used to select memory channels within this designated bank.

- 1) To designate a memory bank, push and hold [BANK] until the "BANK" indicator appears on the function display.



- 2) To release the designation, repeat step 1.
  - "BANK" disappears.

Use the [BANK] switch to select a bank of channels. Each push of [BANK] accesses the next bank.

### Using the [UP]/[DOWN] switches

- 1) Push [BANK] several times until the desired bank appears, if required.
- 2) Push [UP] or [DOWN] to select the desired memory channel.

#### [EXAMPLE]

Selecting memory channel 345.



Push 2 times.

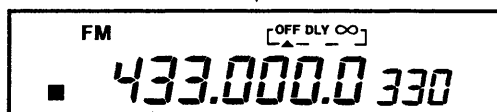

Push 15 times or hold continuously until 345 appears.



### Using the keyboard

- 1) Push keys for the desired memory channel number (0 ~ 899) on the keyboard.
  - If a wrong number is entered, push [CE] and enter the correct number.
- 2) Push [Mch] to select a memory channel.

#### [EXAMPLE]

Selecting memory channel 73.

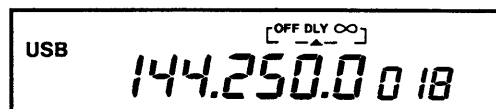

Push .



**NOTE:** Scan edge channels can be selected by entering numbers 900 ~ 919. See p. 18 for details. (e. g. To select program scan edge channel 9P1, push [9] [1] [8] [Mch].)

### Using the main dial

- 1) Push [BANK] several times until the desired bank appears, if required.
- 2) While pushing [Mch], rotate the main dial.

**NOTE:** Click sounds of the internal relay may be heard when changing the memory channel. This is not a malfunction.

#### [EXAMPLE]

Selecting memory channel 622.



Push 5 times.



While pushing rotate .

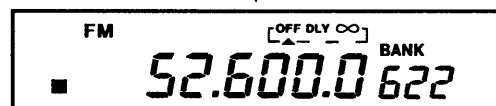

## 4 MEMORY CHANNELS

### Memory writing

#### • Normal writing

This is the way to program a frequency, mode and tuning step. Scan edge programming is also possible.

- 1) Select the desired memory channel. (p. 16)
- 2) Set the desired frequency. (p. 12)
  - When the memory channel already contains information, change the frequency using the main dial or the keyboard.
  - When the memory channel is a blank channel, set the frequency using the keyboard.
- 3) Set the desired mode and tuning step.
- 4) Push and hold [MW] until the receiver emits 3 beeps.
  - The information is stored in the memory channel.

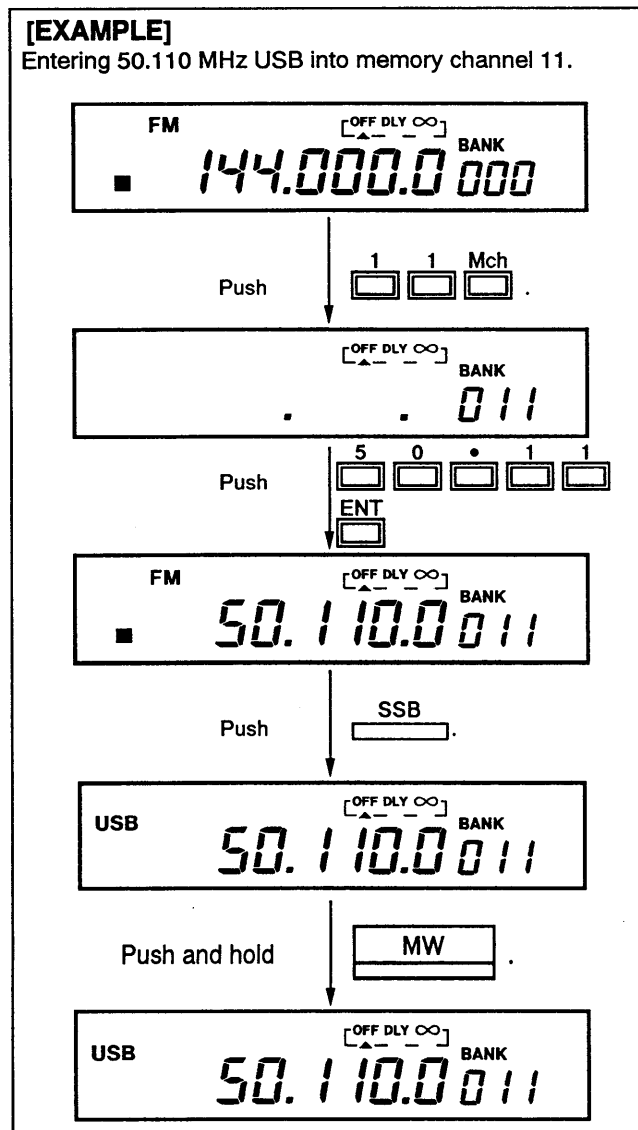

#### • Writing a frequency into a memory channel not displayed

This is useful when programming a newly detected station frequency into a memory channel such as a blank memory channel.

- 1) While pushing [M-SET], rotate the main dial to select the memory channel to be used.
  - [UP]/[DOWN] switches can also be used.
- 2) Release [M-SET].
  - The previous selected frequency appears.
- 3) Push and hold [MW] until the receiver emits 3 beeps.

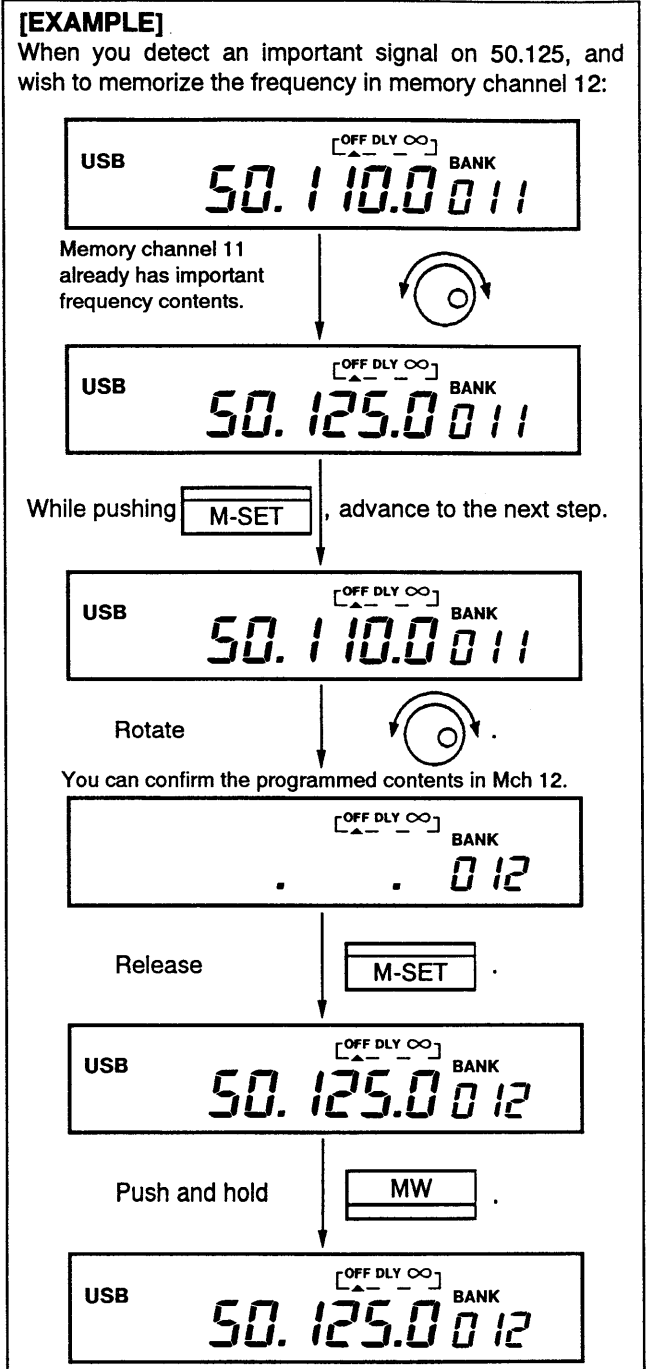

## ■ Contents clearing

- 1) Select the memory channel to be cleared.
  - Scan edge channels cannot be cleared.
- 2) Push and hold [M-CL] until the receiver emits 3 beeps.
  - All contents in the memory channel have been cleared.

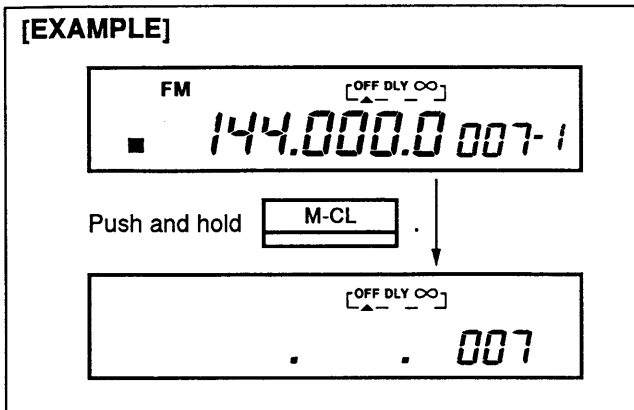

## ■ Searching for memory channels programmed with the same frequency

Memory channels that are programmed with the same frequency can be checked to prevent programming one frequency on more than one memory channels

While pushing [M-SET], push [Mch] to search the memory channels.

- When another memory channel(s) is programmed with that frequency, the memory channel number changes to that channel.

## ■ Window

The IC-R7100 has 2 windows, front window and back window, to show memory channels. Each window can have one memory channel, and you can exchange the window using the [WINDOW] switch.

Operations are only performed on the front window. you must exchange the window to use the memory channel on the back window.

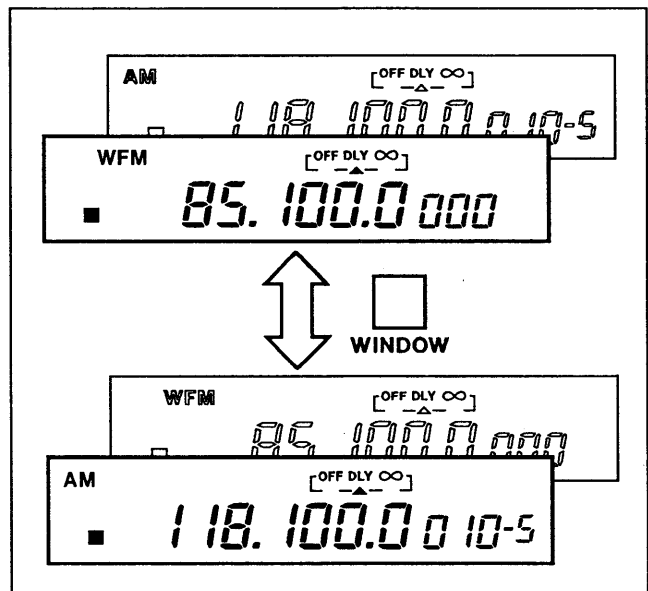
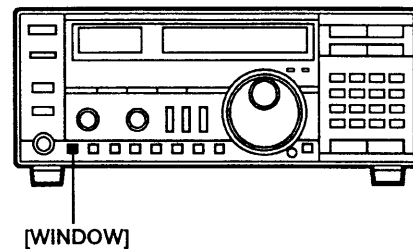

### SCAN EDGE CHANNEL NUMBERS CORRESPONDING CHART

Scan edge group	Displayed number	Assigned number	Scan edge group	Displayed number	Assigned number
Group 0	0P1	900	Group 5	5P1	910
	0P2	901		5P2	911
Group 1	1P1	902	Group 6	6P1	912
	1P2	903		6P2	913
Group 2	2P1	904	Group 7	7P1	914
	2P2	905		7P2	915
Group 3	3P1	906	Group 8	8P1	916
	3P2	907		8P2	917
Group 4	4P1	908	Group 9	9P1	918
	4P2	909		9P2	919

# 5 SCANS

## Basic scan

The IC-R7100 has 5 basic scan types and additional functions to suit your requirements.

The following are basic scan types. When additional functions are activated, each one below will perform differently.

### PROGRAMMED SCAN (p. 23)

Repeatedly scans between two programmable frequencies. The receiver has 10 scanning ranges (20 edge frequencies).

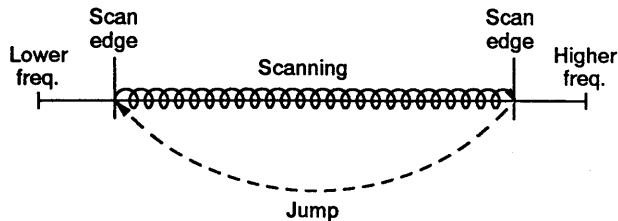

### MEMORY SCAN (p. 23)

Repeatedly scans all memory channels in sequence except blanked memory channels.

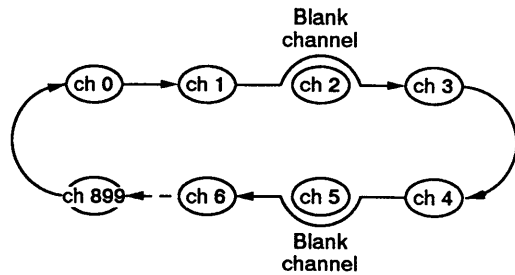

### SELECTED MODE MEMORY SCAN (p. 24)

Repeatedly scans memory channels with the same selected receiving mode.

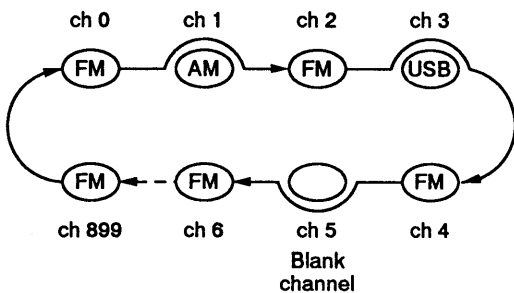

### AUTO MEMORY WRITE SCAN (p. 24)

Automatically programs the received frequency into memory channels 800-899 during programmed scan.

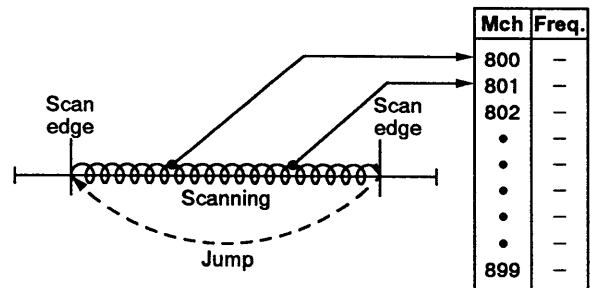

### WINDOW SCAN (p. 25)

Repeatedly changes the window to watch frequencies in the front and back windows. The duty rate can be selected in scan set mode.

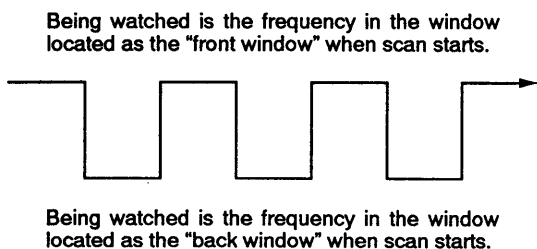

## Advanced scan

A basic scan can be started on the back window side at the same time as window scan is started. This is

an advanced scan. Depending on the duty cycle, the front window and back window can be alternately watched with a basic scan being performed on the back window side.

**WINDOW PROGRAMMED SCAN** (p. 25)  
 Repeatedly scans between 2 scan edge frequencies on the back window side during the window scan. This scan is a combination of window scan and programmed scan.

Being watched is the frequency in the window located as the "front window" when scan starts.

Programmed scan is activated in the window located as the "back window" when scan starts.

**WINDOW MEMORY SCAN** (p. 26)  
 Repeatedly scans memory channels in sequence except for blanked memory channels on the back window side during window scan. This scan is a combination of window scan and memory scan.

Being watched is the frequency in the window located as the "front window" when scan starts.

Memory scan is activated in the window located as the "back window" when scan starts.

**WINDOW SELECTED MODE MEMORY SCAN** (p. 26)  
 Repeatedly scans memory channels with the same selected receiving mode on the back window side during window scan. This is a combination of window scan and selected mode memory scan.

Being watched is the frequency in the window located as the "front window" when scan starts.

Selected mode memory scan is activated in the window located as the "back window" when scan starts.

**WINDOW AUTO MEMORY WRITE SCAN** (p. 27)  
 Automatically programs the received frequency into memory channels: 800 ~ 899 during programmed scan on the back window side during window scan. This is a combination of window scan and auto memory write scan.

Being watched is the frequency in the window located as the "front window" when scan starts.

Mch	Freq.
800	—
801	—
802	—
•	—
•	—
•	—
899	—

Auto memory write scan is activated in the window located as the "back window" when scan starts.

**ADVANCED SCANS PERFORMANCE EXAMPLE**  
 Scan type : Window programmed scan  
 Scan range : 144~146 MHz Back window  
 Duty rate : 3:1

\*When no signal is received.

3 sec.\* 1 sec.\*

Scan start

Front window

Back window

Programmed scan is activated.

## Skip function

Undesired frequencies or memory channels can be skipped during scan operation.

### FOR PROGRAMMED SCAN, AUTO MEMORY WRITE SCAN

When the busy-stop frequency has been programmed into a memory channel and has been programmed as a skip channel, the scan skips the frequency.

To activate the function, push [SKIP].

- "SKIP" appears.

To deactivate the function push [SKIP] again.

- "SKIP" disappears.

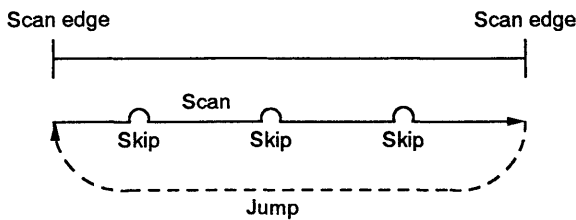

### • Skip frequency programming DURING SCAN

When the scan stops on an undesired frequency, push and hold [MW] for 3 sec. while the scan pauses.

- The frequency is automatically written as a skip channel, and memory channels 700 ~ 799 are used in this sequence for this purpose.

### DURING NORMAL RECEPTION

Write the frequency to be skipped in a desired memory channel with "S" as the select number.

(p. 15)

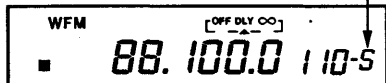

### FOR MEMORY SCAN, SELECTED MODE MEMORY SCAN

A memory channel programmed as a skip channel cannot be scanned.

- A skip channel must be programmed before starting the scan.

To activate the function, push [SKIP].

- "SKIP" appears.

To deactivate the function, push [SKIP] again.

- "SKIP" disappears.

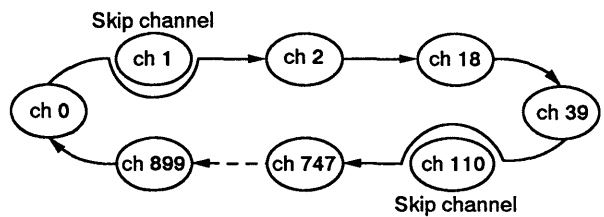

### • Skip channel programming

- 1) Select a memory channel to be programmed as a skip channel.
- 2) Program "S" as the select number. (p. 17)

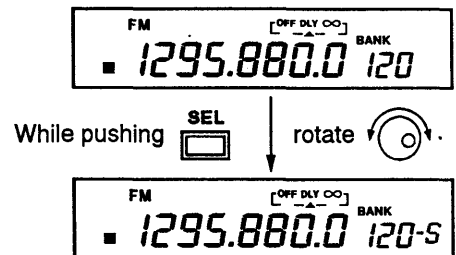

## Voice scan control function

When the busy stop frequency or memory channel does not include a modulated signal, the scan resumes after 1 sec.

To activate the function, push [VSC].

- "VSC" appears.

To deactivate the function, push [VSC] again.

- "VSC" disappears.

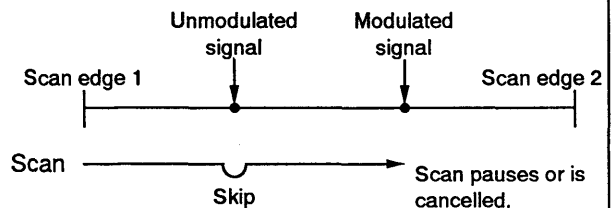
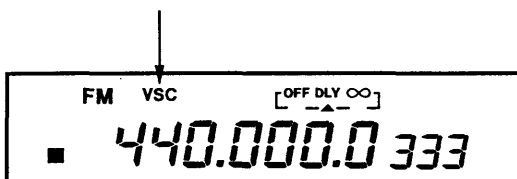

**NOTE:** The scan determines in 1 sec. or less whether the received signal is modulated or not modulated.



## Scan resume condition

The scan pauses when it finds a signal, and then resumes or is canceled depending on the selectable scan resume condition. The receiver has 3 scan resume conditions.

Push [DELAY] to select the resume condition.

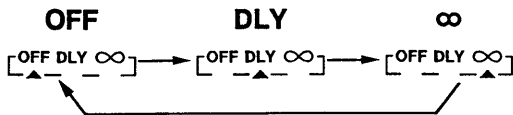

**OFF**  
Scan pauses while receiving a signal and resumes approx. 2 sec. after the signal disappears.

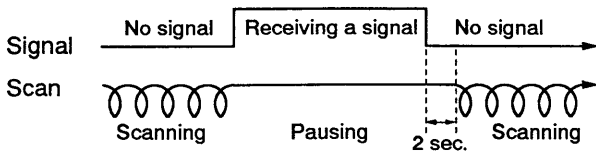

**DLY**  
Scan pauses for a set period and resumes even though the signal continues. See the right box for the period setting.

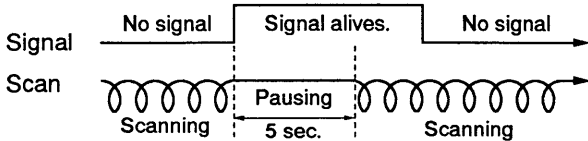

**∞**  
Scan is canceled when a signal is received and the receiver remains indefinitely on this frequency.

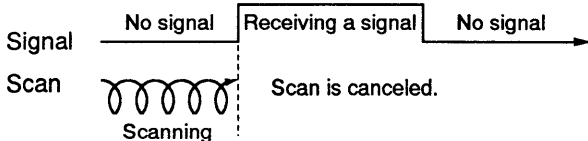

## Scan SET mode

The scan SET mode has 4 functions that are seldom changed as shown in the diagram below.

**NOTE:** These functions can also be adjusted during scanning.

- 1) Push [SCAN].
- 2) Push [•] (S-SET).  
• A scan SET mode function appears.
- 3) Push [UP]/[DOWN] to select the desired function to be set.
- 4) Rotate the main dial to set the contents of the function.
- 5) Push [SCAN] to return to the operating mode.

### OPERATING MODE



### SCAN SET MODE

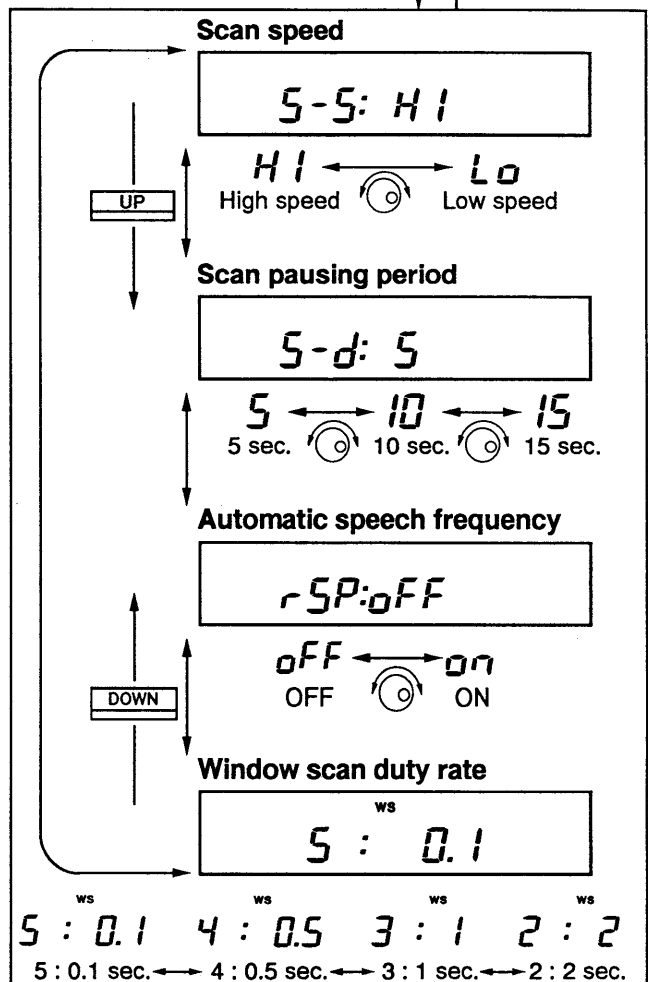

## Basic scan operation

### • Programmed scan

- 1) Set the scan edge frequencies. See the box below.
  - Up to 10 scan edge pairs can be programmed.
- 2) Set the squelch to the threshold position.
  - Squelch threshold information is described in the box below
- 3) Select the desired resume condition.
  - Push [DELAY] to change the condition.
- 4) Push [SCAN].
  - "Scn:" appears.
- 5) While pushing [3](PROG), rotate the main dial to select a scan edge group number (0-9).
  - If [3](PROG) is not held, the last used scan edge group is selected.
- 6) Release [3](PROG) to start the scan.
- 7) While scanning, the following settings can be changed. See the box on p. 25 for details.
  - Scan group
  - Skip function
  - VSC function
  - Resume condition
  - Scan direction
  - Mode
  - Tuning step
  - Scan set mode contents
- 8) To stop the scan, push [UP](STOP).

### • Memory scan

- 1) Set the squelch to the desired position.
  - Push [DELAY] to change the condition.
- 2) Select the desired resume condition.
  - Push [DELAY] to change the condition.
- 3) To designate a memory bank, push and hold [BANK] for 2 sec. to display "BANK."
  - Each push of [BANK] will select the next bank.
- 4) Push [SCAN].
  - "Scn:" appears.
- 5) While pushing [6](MEMO), rotate the main dial to select "AL" or the desired select-number (0-9).
  - When "AL" is selected, all programmed memory channels are checked. (All-memory scan)
  - When the select-number is selected, only memory channels that have the specified select-number are scanned. (Select-number memory scan)
  - If [6](MEMO) is not held, the last used select-number is selected.
- 6) Release [6](MEMO) to start the scan.
- 7) While scanning, the following settings can be changed. See the box on p. 25 for details.
  - Skip function (All-memory scan only)
  - VSC function
  - Resume condition
  - Select number
  - Scan direction
  - Tuning step
  - Scan set mode contents
- 8) To stop the scan, push [UP](STOP).

### SQUELCH SETTING

Set the squelch before starting a scan.

- Rotate [SQUELCH] to the point at which noise is muted for the scan which searches for frequencies having the same mode.
- Set [SQUELCH] to the 12 o'clock position or further clockwise for scans such as memory scan which search frequencies with different modes.

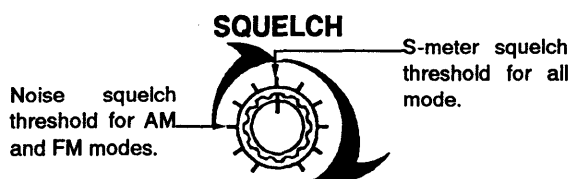

### SCAN EDGE PROGRAMMING

A set of scan edge frequencies must be programmed before starting the programmed or auto memory write scan.

Memory channels 0P1-9P9 are scan edge channels. 0P1 and 0P2, 1P1 and 1P2, ..., 9P1 and 9P2 are pairs of scan edges.

- 1) Write the lower frequency of the scan range into one scan edge channel such as 0P1.
  - Mode and tuning step can also be written.
  - See p. 17 "Memory writing (Normal writing)" for procedure.
- 2) Write the higher frequency of the scan range into another scan edge channel 0P2.

• **Selected mode memory scan**

- 1) Set the squelch to the desired position.
- 2) Select the desired resume condition.
  - Push [DELAY] to change the condition.
- 3) To designate a memory bank, push and hold [BANK] for 2 sec. to display "BANK" if you desire.
  - Each push of [BANK] will select the next bank.
- 4) Push [SCAN].
  - "Scn:" appears.
- 5) While pushing [9](MODE), select the desired operating mode with the mode switches.
  - If [9](MODE) is not held, the mode that is indicated before pushing [SCAN] is selected.
- 6) Release [9](MODE) to start the scan.
  - Selected mode blinks during scanning.
  - When the non-programmed mode is selected, scan does not start.
- 7) While scanning, the following settings can be changed. See the box on p. 25 for details.
  - Skip function
  - VSC function
  - Resume condition
  - Scan direction
  - Mode
  - Tuning step
  - Scan set mode contents
- 8) To stop the scan, push [UP](STOP).

**NOTE:** The receiver will not distinguish AM W from AM and FM N from FM during selected mode memory scan. But the receiver will distinguish USB and LSB.

• **Auto memory write scan**

- 1) Set scan edge frequencies. See the box on p. 23 for procedure.
- 2) Set the squelch to the desired position.
- 3) Select the desired resume condition. (p. 22)
  - Either "OFF" or "DLY" must be selected.
- 4) Push [SCAN].
  - "Scn:" appears.
- 5) While pushing [CE](AUTO), rotate the main dial to select the scan edge group number (0-9) and the clear start or non-clear start condition.
  - To select clear start, while pushing [CE](AUTO), rotate the main dial until "cL" appears.
  - When clear is selected, all memory channels in memory bank 8 become blank channels, and all channels are used for auto memory write. (p. 27)
  - When non-clear is selected, only the blank channels are used for auto memory write. (p. 27)
  - If [CE](AUTO) is not held, the last used scan edge group with non-clear start is automatically selected.
- 6) Release [CE](AUTO) to start the scan.
- 7) While scanning, the following settings can be changed. See the box on p. 25 for details.
  - Skip function
  - VSC function
  - Resume condition
  - Scan direction
  - Mode
  - Tuning step
  - Scan set mode contents
- 8) To stop the scan, push [UP](STOP).
  - The scan automatically stops if the scan writes frequencies into all memory channels in memory bank 8.

**SELECTED MEMORY FUNCTION**

When operating the memory scan, both the memory bank and select-number designations can be used.

① **When designating a memory bank:**

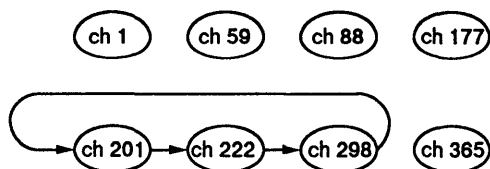

Only programmed memory channels in the designated bank are checked.

② **When designating a select-number:**

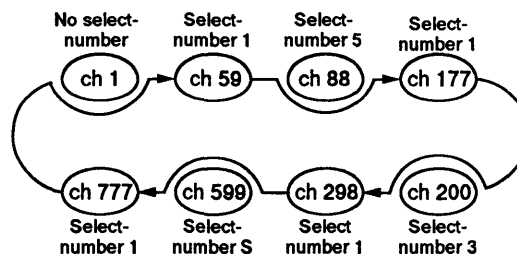

Only programmed memory channels in the designated bank are checked.

• **Window scan**

- 1) Set the frequency or select the memory channel in the back window.
  - To change the window, push [WINDOW].
- 2) Set the squelch to the desired position.
- 3) Select the desired resume condition.
  - Push [DELAY] to change the condition.
- 4) Push [SCAN].
  - "Scn:" appears.
- 5) Push [1](WS) to start the scan.
  - The front and back window will be alternately watched.
  - While the back window frequency is being watched, "WS," "▲" (the scan resume indicator), and both decimal points are blinking.
- 6) While scanning, the following settings can be changed. See the box below for details.
  - VSC function
  - Resume condition
  - Window
  - Scan set mode contents
- 7) To stop the scan push [DOWN](W-STOP).

■ **Advanced scan operation**

• **Window programmed scan**

- 1) Set the scan edge frequencies. (See the box on p. 23 for details.)
  - Up to 10 pairs of scan edges can be programmed.
- 2) Set the squelch to the desired position.
- 3) Select the desired resume condition.
  - Push [DELAY] to change the condition.
- 4) Push [SCAN].
  - "Scn:" appears.
- 5) While pushing [2](W-PR), rotate the main dial to select the scan edge group number (0~9).
  - If [2](W-PR) is not hold, the last used scan edge group is selected.
- 6) Release [2](W-PR) to start the scan.
  - "WS" appears when the front window frequency is watched.
  - "WS," "▲" (scan resume indicator), and both decimal points blink while programmed scan is performed.
- 7) While scanning, the following settings can be changed. (See the box below for details.)
  - Skip function
  - VSC function
  - Resume condition
  - Window
  - Scan set mode contents
- 8) To stop the scan, push [DOWN](W-STOP).

**DURING SCAN OPERATION**

The following switches and keys can be used during scan.

**NOTE:** Some switches and keys are not available for advanced scans. Push [WINDOW] to change the window manually for advanced scan control.

① **MAIN DIAL**

- Changes the scan direction.
- Resumes the scan manually while the scan is paused.

② **MODE SWITCHES**

Change the mode during mode-select scan, programmed scan and auto memory write scan.

③ **DIGIT KEYS**

- Change the scan edge group number in the programmed or auto memory write scan.
- Change the select-number in the memory scan.
  - The [ • ] key selects the all-memory scan.

④ **[TS]**

Changes the tuning step with the main dial in programmed scan.

⑤ **[S-SET]**

Selects scan SET mode after pushing [SCAN].
 

- All contents can be changed during scan operation.

⑥ **[WINDOW]**

Changes the window.

### • Window memory scan

- 1) Set the squelch to the desired position.
- 2) Select the desired resume condition.
  - Push [DELAY] to change the condition.
- 3) To designate a memory bank, push and hold [BANK] for 2 sec. to display "BANK" if you desire.
  - Each push of [BANK] will select the next bank.
- 4) Push [SCAN].
  - "Scn:" appears
- 5) While pushing [5](W-ME), rotate the main dial to select "AL" or the desired select-number (0~9).
  - When "AL" is selected, all programmed memory channels are checked. (Window all-memory scan)
  - When the select-number is selected, only memory channels that have the specified select-number are scanned. (Window select-memory scan)
  - If [5](W-ME) is not held, the last used select-number is selected.
- 6) Release [5](W-ME) to start the scan.
  - "WS" appears when the front window frequency is watched.
  - "WS," "▲" (scan resume indicator), and both decimal points blink while memory scan is performed.
- 7) While scanning, the following settings can be changed. See the box on p. 25 for details.
  - Skip function (Window all-memory scan only) (p. 21)
  - VSC function
  - Resume condition
  - Window
  - Scan set mode contents
- 8) To stop the scan, push [DOWN](W-STOP).

### • Window selected mode memory scan

- 1) Set the squelch to the desired position.
- 2) Select the desired resume condition.
- 3) To designate a memory bank, push and hold [BANK] for 2 sec. to display "BANK" if you desire.
  - Each push of [BANK] will select the next bank.
- 4) Push [SCAN].
  - "Scn:" appears.
- 5) While pushing [8](W-MO), select the desired operating mode with the mode switches.
  - If [8](W-MO) is not held, the last used mode is selected.
- 6) Release [8](W-MO) to start the scan.
  - When a non-programmed mode is selected, scan does not start.
  - "WS" appears when the front window frequency is watched.
  - "WS," "▲" (scan resume indicator), and both decimal points blink while selected mode memory scan is performed.
- 7) While scanning, the following settings can be changed. See the box on p. 25 for details.
  - Skip function
  - VSC function
  - Resume condition
  - Window
  - Scan set mode contents
- 8) To stop the scan, push [DOWN](W-STOP).

**NOTE:** The receiver will not distinguish AM W from AM and FM N from FM during selected mode memory scan. But the receiver will distinguish USB and LSB.

### SELECT-NUMBER WRITING

You can program a select-number into the desired memory channel. Skip channel programming is also possible. A single memory channel, however, cannot be programmed both.

- 1) Select a memory channel.
  - A select-number cannot be written in blank memory channels or in scan edge channels.
- 2) While pushing [SEL], rotate the main dial to select the desired select-number, 0~9.
  - Select-number "S" is used for a skip channel. If you wish to set the memory channel as a skip channel, select "S."

- 3) Release [SEL].
  - The select-number is set.

- 4) To cancel the select-number, push [SEL].

### CLEARING A SELECT-NUMBER

A single select-number can be cleared from all channels at the same time.

- 1) Select a memory channel having the select-number to be cleared.
- 2) While pushing [SEL], push and hold [M-CL] until 3 beeps sound.
  - The select-number has been cleared.

## 5 SCANS

### • Window auto memory write scan

- 1) Set the scan edge frequencies. See the box on p. 23 for details.
  - Up to 10 pairs of scan edges can be programmed.
- 2) Set the squelch to the desired position.
- 3) Select the desired resume condition.
  - Either "OFF" or "DLY" must be selected.
- 4) Push [SCAN].
  - "Scn:" appears.
- 5) Push and hold [0](W-AU) and rotate the main dial
  - To select clear start, while pushing [0](W-AU), rotate the main dial until "cL" appears.
  - When clear is selected, all memory channels in memory bank 8 become blank channels, and all channels are used for auto memory write.
  - When non-clear is selected, only the blank channels then are used for auto memory write.
  - If [0](W-AU) is not held, the last used scan edge group with non-clear start is automatically selected.
- 6) Release [0](W-AU) to start the scan.
  - "WS" appears.
- 7) While scanning, the following settings can be changed. See the box on p. 25 for details.
  - Skip function
  - VSC function
  - Resume condition
  - Scan direction
  - Mode
  - Tuning step
  - Scan set mode contents
- 8) To stop scan, push [DOWN](W-STOP).
  - The scan automatically stops if the scan writes frequencies into all memory channels of bank 8.

### [EXAMPLE]: CLEAR OR NON-CLEAR FOR AUTO MEMORY WRITE AND WINDOW AUTO MEMORY WRITE SCANS

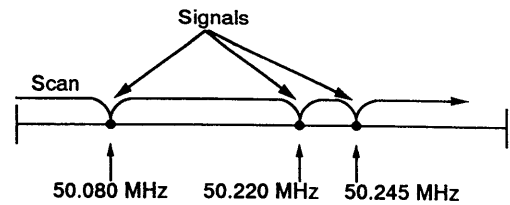

#### ① When selecting clear start:

Mch number	Frequency
800	144.057 MHz
801	144.880 MHz
802	-----
803	145.000 MHz
804	-----



Mch number	Frequency
800	50.080 MHz
801	50.220 MHz
802	50.245 MHz
803	-----
804	-----

#### ② When selecting non-clear start:

Mch number	Frequency
800	144.057 MHz
801	144.880 MHz
802	-----
803	145.000 MHz
804	-----



Mch number	Frequency
800	144.057 MHz
801	144.880 MHz
802	50.080 MHz
803	145.000 MHz
804	50.220 MHz

### SCAN NOTES

- ① The scan type can be changed during scan.
  - Squelch re-setting may be required.
- ② When operating an advanced scan, the frequency on the front window can be changed by the main dial or keyboard.
  - Use of the keyboard will pause the scan until [ENT] is pushed for frequency input.
  - The memory channel can be changed using the keyboard or the main dial while holding [Mch].
- ③ The scan can be independently operated on the front and back windows.
  - Push [WINDOW] to change the window manually.
- ④ When the window is changed manually during basic scan, the scan pauses; now, scan can neither be canceled nor resumed until the window is changed again.
- ⑤ When the window is changed manually during an advanced scan, the duty cycle and stop switches are reversed.
  - The advanced scan may be changed to window scan or to a basic scan automatically depending on the scan condition and way of stopping the scan.
  - To stop the scan completely, push both [UP](STOP) and [DOWN](W-STOP).

## Dual scan operation

A basic scan and an advanced scan can be used alternately. For example, you can operate programmed scan and window memory scan, or memory scan and window memory scan, etc.

Followings are some examples. Combine 2 scans as you desire.

The duty rate of the selected basic scan and advanced scan can be set in scan SET mode. (p. 22)

**NOTE 1:** You can start dual scan from either basic scan or window scan functions, and can stop either scan.

**NOTE 2:** If you reverse the front and back windows during dual scan operation, the scan stop switches ([STOP]/[W-STOP]) may be reversed.

**NOTE 3:** The squelch threshold point differs depending on the receiving mode.

**NOTE 4:** When the AFC function is activated, the frequency may be moved even when the scan pauses.

### PROGRAMMED SCAN + WINDOW PROGRAMMED SCAN

2 different scan ranges can be searched alternately.

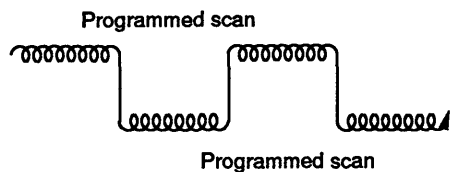

- 1) Start the programmed scan.
  - Push [SCAN], then [3](PROG).
- 2) Start the window programmed scan.
  - Push [SCAN], then [2](W-PR).
- 3) To stop the scans, push [UP](STOP) and [DOWN](W-STOP).

### PROGRAMMED SCAN + WINDOW MEMORY SCAN

While searching for unknown stations, already memorized frequencies can be checked.

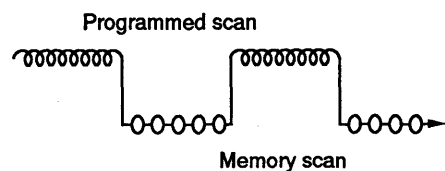

- 1) Start the programmed scan.
  - Push [SCAN], then [3](PROG).
- 2) Start the window memory scan.
  - Push [SCAN], then [5](W-ME).
- 3) To stop the scans, push [UP](STOP) and [DOWN](W-STOP).

### SELECTED MODE MEMORY SCAN + WINDOW SELECTED MODE MEMORY SCAN

2 different modes can be used for the mode select scan.

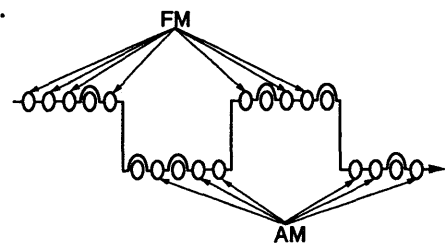

- 1) Start the selected mode memory scan.
  - Push [SCAN], then [9](MODE).
- 2) Start the window selected mode memory scan.
  - Push [SCAN], then [8](W-MO).
- 3) To stop the scans, push [UP](STOP) and [DOWN](W-STOP).

### MEMORY SCAN + WINDOW SCAN

During memory scan, the preset frequency on the back window can be checked.

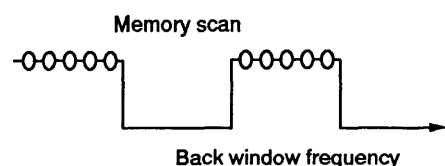

- 1) Start the memory scan.
  - Push [SCAN], then [6](MEMO).
- 2) Start the window scan.
  - Push [SCAN], then [1](WS).
- 3) To stop the scans, push [UP](STOP) and [DOWN](W-STOP).

## ■ Clock and timer mode

The IC-R7100 has a built-in 24-hour clock with 5 sets of ON/OFF-timer functions.

The ON/OFF-timer automatically turns power ON and OFF at a preset time. 5 pairs of timers can be combined in 24 hours, so the receiver can automatically turn ON and OFF up to 10 times in one day.

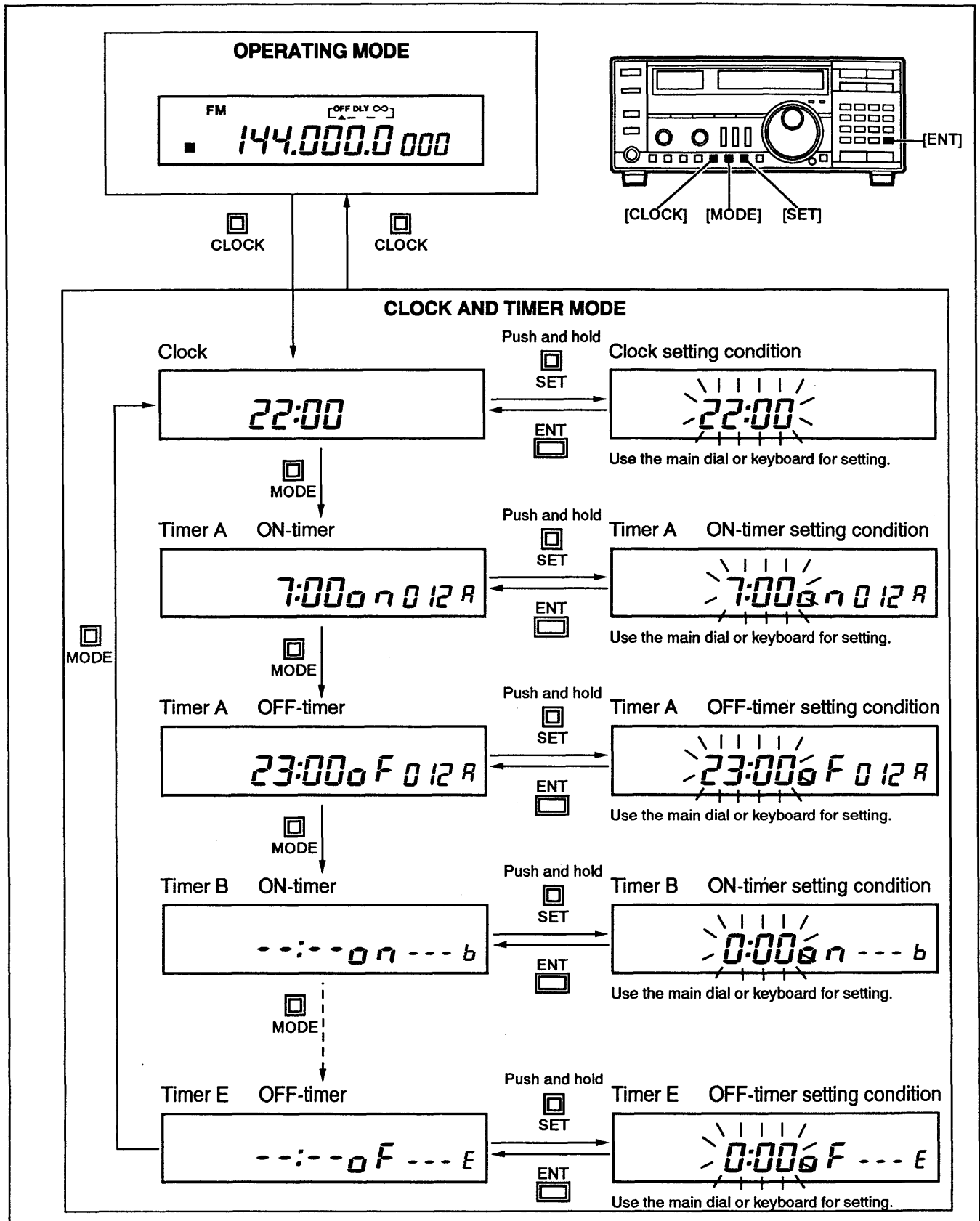



## ■ Clock adjustment

### • Using the main dial

- 1) Push [TIMER] OUT.
- 2) Push [CLOCK] to enter the clock and timer mode.
  - The function display shows the clock time.
- 3) Push and hold [SET] until the receiver emits 3 beeps.
  - The displayed time blinks.
- 4) Rotate the main dial to adjust the time.
- 5) Push [ENT] on the keyboard to set the time.
- 6) To return to the operating mode, push [CLOCK] again.

#### [EXAMPLE]

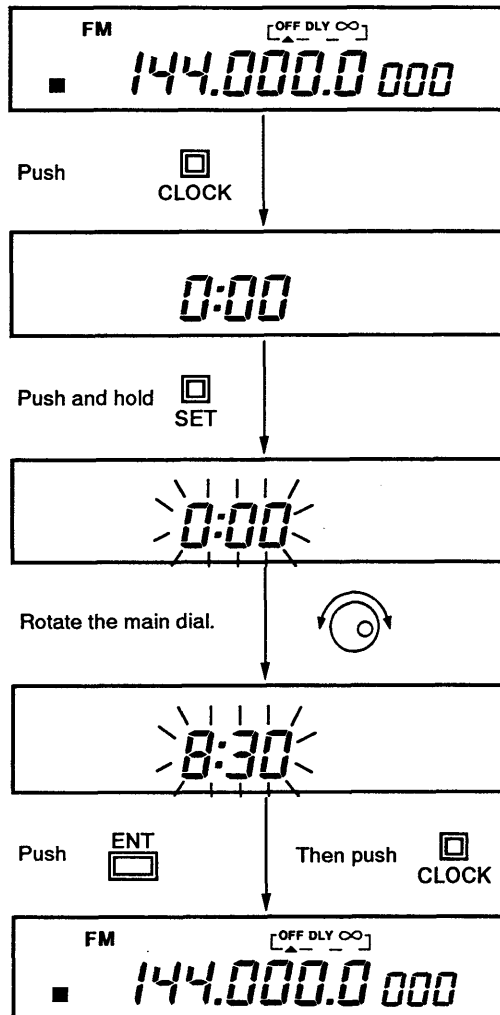

There are 2 ways to adjust the built-in clock.

- Using the main dial
- Using the keyboard

### • Using the keyboard

- 1) Push [TIMER] OUT.
- 2) Push [CLOCK] to enter the clock and timer mode.
  - The function display shows the clock time.
- 3) Push and hold [SET] until the receiver emits 3 beeps.
  - The displayed time blinks.
- 4) Enter the time (4 digits) using the keyboard.
  - 8:25 : Push the [0], [8], [2], [5] keys.
  - 14:57 : Push the [1], [4], [5], [7] keys.
- 5) When entering a wrong digit, push the [CE] key, then enter again.
- 6) Push [ENT] to set the time.
  - The receiver does not accept 24:00 or more.
- 7) To return to the previous mode, push [CLOCK].

#### [EXAMPLE]

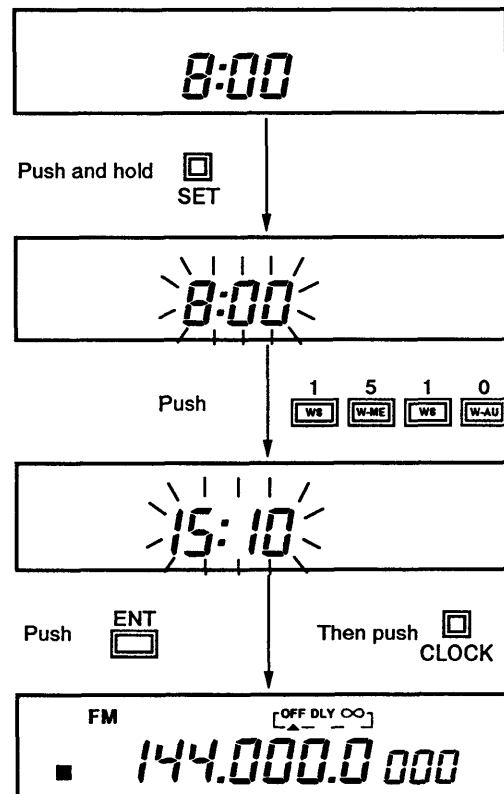

## Timer programming

### Setting the timer time

- 1) If the timer is activated, push [TIMER] OUT.
- 2) Push [CLOCK] to enter the clock and timer mode.
  - The function display shows the clock time.
- 3) Push [MODE] several times to select the desired ON-timer or OFF-timer to be programmed.
  - Timer A ~ Timer E is available.
  - "on" appears when selecting the ON-timer.
  - "oF" appears when selecting the OFF-timer.
- 4) Push and hold [SET] until the receiver emits 3 beeps.
  - The displayed time blinks.
- 5) Set the desired time to be turned ON and OFF using the main dial or keyboard as described on p. 30 "Clock adjustment."
- 6) Push [ENT] key to set the time.
- 7) To program the other timer, push [MODE] to select the timer, and then begin from step 3 again.
- 8) To return to the previous mode, push [CLOCK].

**NOTE:** Once the timer time is set, the time cannot be cleared. Only over-writing is possible. Turning the timer condition OFF is also possible as described at right.

### Setting the timer condition as effective or ineffective

- 1) If the timer is activated, push [TIMER] OUT.
- 2) Push [CLOCK] to enter the clock and timer mode.
  - The function display shows the clock time.
- 3) Select the timer which will be set as effective or ineffective.
  - Push [MODE] several times until the desired timer appears.
- 4) Push [SET] to change its condition.
  - DO NOT hold [SET]. When the switch is held for more than 3 sec., the timer enters the setting condition.
  - The timer is effective when the set time is displayed.
  - The timer is ineffective when "--:--" is displayed.

Effective condition



Push SET

Ineffective condition



- 5) To change the condition of the other timers, begin from step 2.
- 6) Push [CLOCK] to return to the operating mode.

### [EXAMPLE]

When programming 08:30 as ON-time and 17:30 as OFF-time of timer B.

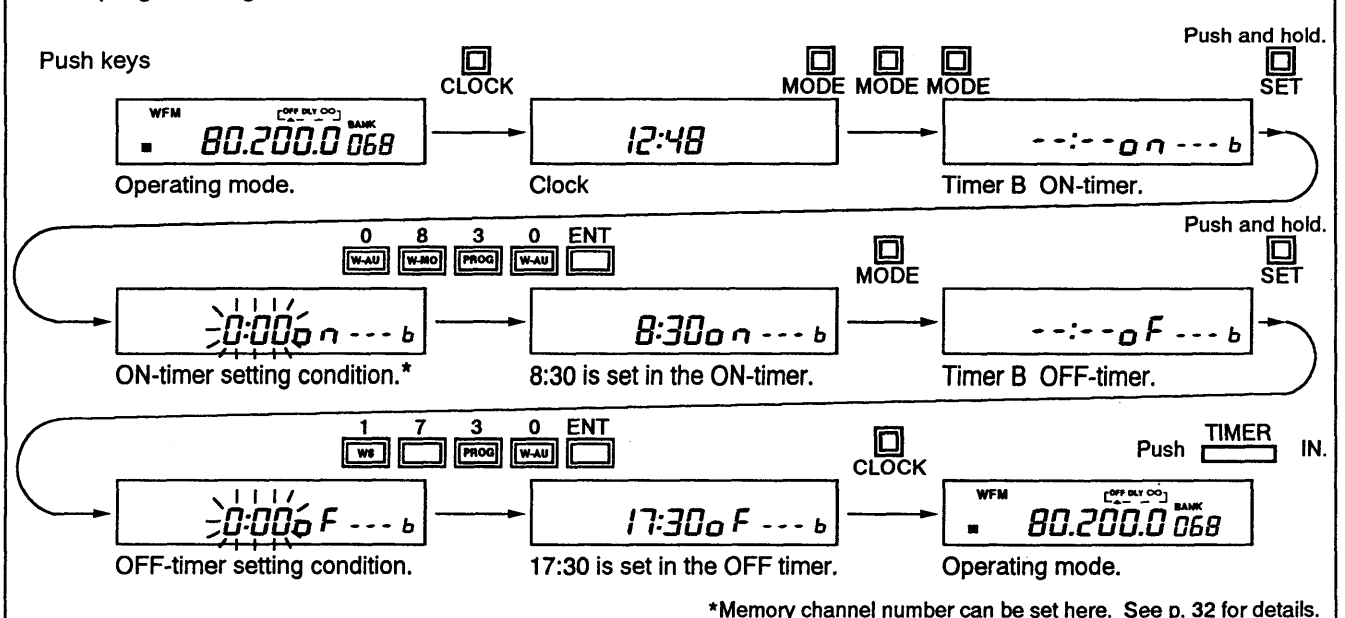

\*Memory channel number can be set here. See p. 32 for details.

**• Programming a memory channel to be selected by the ON-timer**

You can program a memory channel to be selected by the ON-timer.

- 1) If the timer is activated, push [TIMER] OUT.
- 2) Push [CLOCK] to enter the clock and timer mode.
  - The function display shows the clock time.
- 3) Push [MODE] several times to select the desired ON-timer.
- 4) Push and hold [SET] to enter the clock setting condition.
  - 3 beeps are emitted.
  - The displayed time blinks.
- 5) While pushing [Mch], rotate the main dial to select the memory channel that will be selected at timer-ON.
- 6) Release [Mch].
  - The displayed time blinks.
- 7) Set the timer time. (p. 31)
- 8) Push [ENT] to set the memory channel and to exit the timer setting condition.
  - The selected memory channel is automatically programmed in the corresponding OFF-timer.

**• Setting an ON-timer as memory effective or memory ineffective**

- 1) Enter the clock setting condition.
  - Follow steps 1 ~ 4 described in the above section.
  - Confirm that the displayed time is blinking.
- 2) Push [Mch] to change the memory channel which will be selected at timer-ON as effective or ineffective.

Memory effective condition

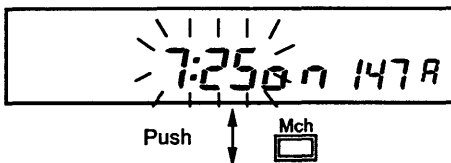

Memory ineffective condition

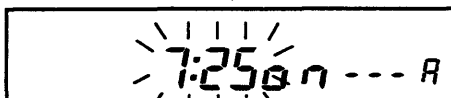

- 3) Push [ENT] to set the condition.
- 4) Push [CLOCK] to return to the operating mode.

**■ Timer operation**

- 1) Set the ON-timer and OFF-timer times. (p. 31)
  - Be sure the set ON-time and OFF-time correspond to the same timer.
  - Only setting the ON-timer or OFF-timer is possible.

- 2) Push [TIMER] IN.

- 3) At the preset ON-time, the receiver power is turned ON automatically.

At the preset OFF-time, the receiver power is automatically turned OFF with 5 beeps.

- 4) To cancel the timer, push [TIMER] OUT.

**NOTE:** Before timer operation, be sure to turn unused timers OFF. If an unused timer is ON, that timer may affect the timer in use.

**[TIMER COMBINATION EXAMPLE]**

- (1) When 2 programs are separate.

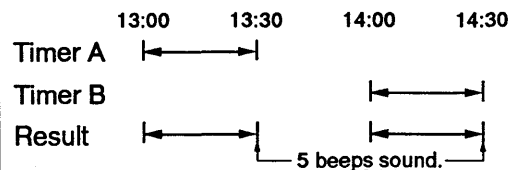

- (2) When the ON time is the same for 2 programs:  
The program which ends later is selected.

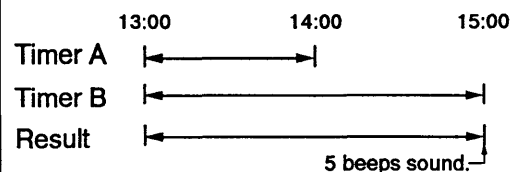

- (3) When the OFF time and ON time are the same on 2 programs:  
2 programs are consecutive.

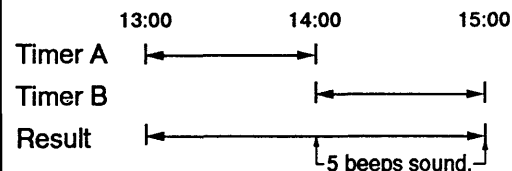

- (4) When 2 programs overlap:  
The program which starts earlier is selected.

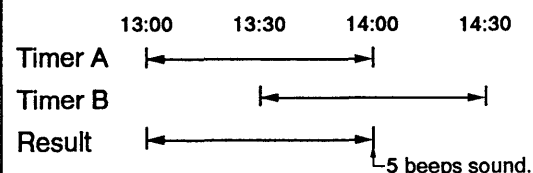

## Disassembling

For internal maintenance and optional installation, disassemble the receiver.

**⚠ WARNING:** DISCONNECT the AC power cable or AC adapter before performing any work on the receiver.

- 1) Unscrew the 12 screws.

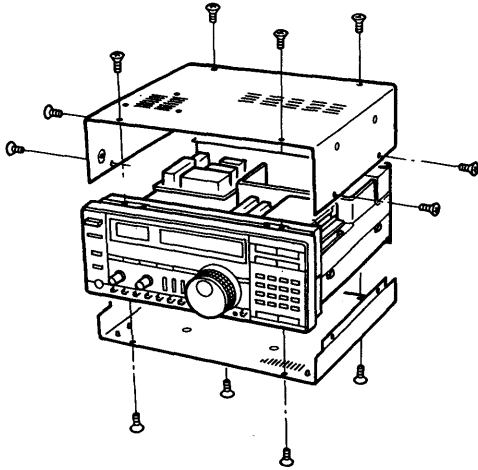

- 2) Remove the top and bottom covers.

- 3) Unscrew the 4 screws.

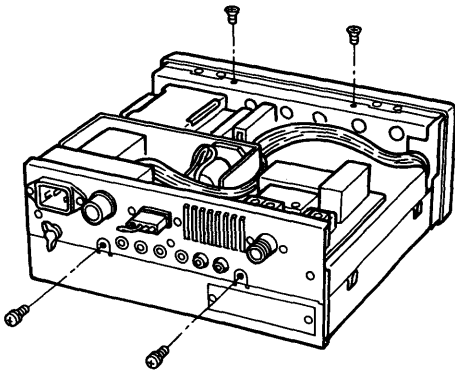

- 4) Remove the wire from the hook located between the REG unit and front panel.

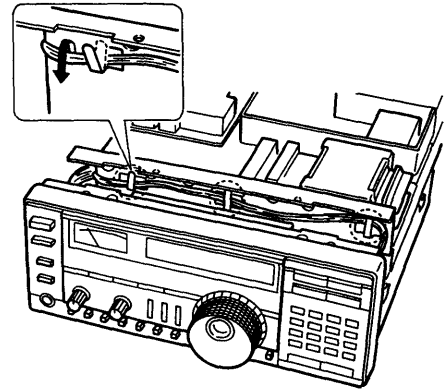

- 5) Move the REG unit.

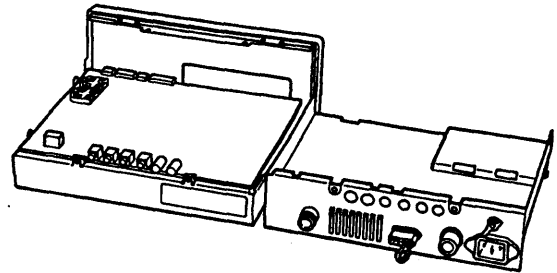

## CPU resetting

Only when the internal CPU malfunctions, reset the CPU.

**NOTE:** CPU resetting clears all memory channel contents and other settings to the initial settings before shipping.

- 1) Turn the power OFF.
- 2) While pushing [MW], turn the power ON.
  - 144.0000 MHz appears.
- 3) Release [MW].
  - The CPU is now reset.

## ■ Fuse replacement

If a fuse blows, find the source of the problem, then replace the damaged fuse with a new, rated fuse.

**⚠ WARNING: DISCONNECT** the AC power cable or AC adapter before changing the fuse.

The IC-R7100 has the following fuses for circuit protection.

- AC power input fuse (AC type only)
- Regulator circuit fuse (AC and DC types)
- DC power cable fuse (DC type only)

### • AC power input fuse (AC type only)

During AC operation, this fuse may blow.

- 1) Unscrew the [FUSE] holder on the rear panel using a Phillips screwdriver.
- 2) Replace the damaged fuse with a new, rated fuse.

Voltage	Fuse rating
100 or 117 V AC	FGB 1 A
240 V AC	FGB 0.5 A
220 V AC	FGMT4 0.5 A

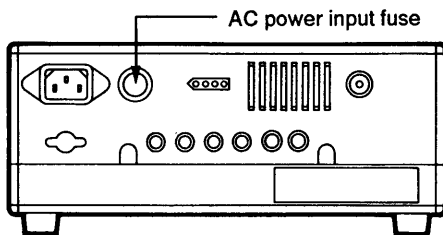

### • Regulator circuit fuse (AC and DC types)

During AC or AC adapter operation, this fuse may blow. The regulator circuit fuse is located on the REG unit.

- 1) Remove the top cover. (p. 33)
- 2) Replace the damaged regulator fuse with a new, FGB 2 A fuse.

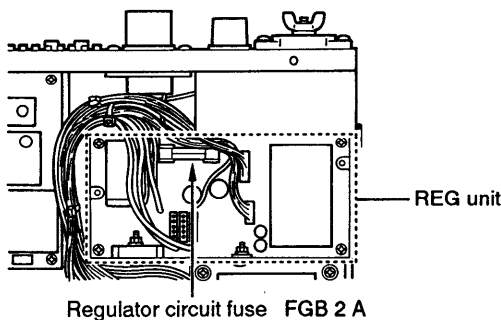

- 3) Replace the top cover.

### • DC power cable fuse (DC type only)

During DC operation using the DC power cable, this fuse may blow. Replace the damaged DC power cable fuse with a new, FGB 3 A fuse.

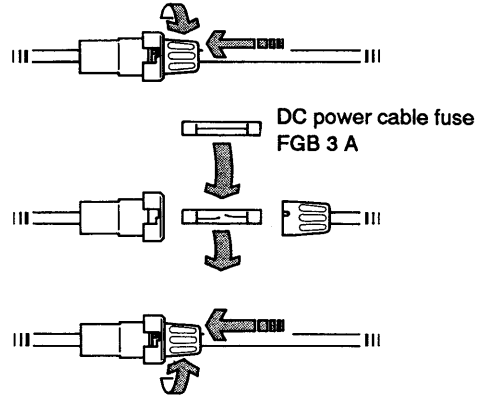

## ■ AC voltage modifications

(AC type, except for Germany)

Usable AC voltage varies according to versions. However, usable AC voltage can be modified.

**⚠ WARNING: DISCONNECT** the AC power cable before performing modifications.

According to AC voltage, replace the AC power input fuse.

- 1) Remove the top cover. (p. 33)
- 2) Change jumper connections on the REG unit.

Voltage	Jumper position	Dummy jumper positions
100 V AC	J2	J3, J4
117 V AC	J3	J2, J4
240 V AC	J4	J2, J3

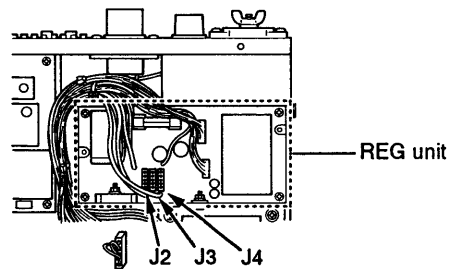

- 3) Replace the top cover.

### ■ Backup batteries

The IC-R7100 has two lithium backup batteries: one for the clock and another for memory backup.

#### CLOCK BATTERY

The usual life of the clock battery is approx. 2 years. When the battery is exhausted, the clock may either lose time or malfunction.

#### MEMORY BACKUP BATTERY

The usual life of the memory backup battery is approx. 5 years. When the battery is exhausted, the receiver operates normally but cannot retain memory information.

#### • Backup battery replacement

**⚠ WARNING: DISCONNECT** the AC power cable or AC adapter before changing a backup battery.

**BE CAREFUL!** Reverse polarity insertion may cause backup battery explosion.

- 1) Remove the top cover and the REG unit. (p. 33)
- 2) Pull up the battery latch, then remove the exhausted battery.
- 3) Insert a new CR2032 or equivalent battery with the ⊕ side up.

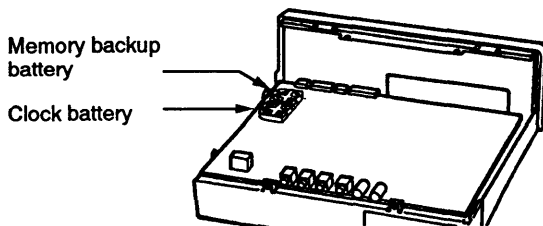

- 4) Reassemble the receiver.
- 5) Adjust the clock time and program memory channels.

### ■ Beep tone ON/OFF

The receiver emits a beep tone each time a switch is pushed. The beep tone can be deactivated.

- 1) Turn the power OFF.
- 2) While pushing [ENT] and [•], turn the power ON.
- 3) Release switches.
  - The beep tone is now deactivated.
- 4) To re-activate the beep tone, repeat steps 1)–3).

**NOTE:** Beep tone level can be adjusted. Refer to p. 38 "Under the REG unit," adjust R101 on the MAIN unit.

### ■ Main dial brake adjustment

The tension of the main dial can be adjusted to suit your operating requirements.

Turn the brake adjustment screw to a comfortable tension level while turning the main dial continuously and evenly in one direction.

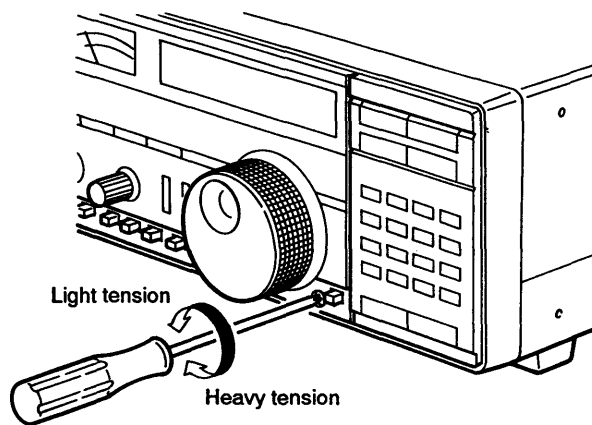

### ■ Cleaning

If the receiver becomes dusty or dirty, wipe it clean with a dry, soft cloth.

**AVOID** the use of strong chemical agents such as benzine or alcohol, as they may damage the receiver's surfaces.

## ■ Troubleshooting

The following chart is designed to help you correct problems which are not equipment malfunctions.

If you cannot solve a problem, contact your nearest Icom Dealer or Service Center.

Problem	Possible cause	Solution	Ref.
<ul style="list-style-type: none"> <li>Power does not turn ON when [POWER] is pushed IN.</li> </ul>	<ul style="list-style-type: none"> <li>DC power cable is improperly connected.</li> <li>A fuse is blown.</li> <li>Timer is activated.</li> <li>During DC operation, battery is exhausted.</li> </ul>	<ul style="list-style-type: none"> <li>Reconnect the DC power cable securely.</li> <li>Check for the cause, then replace the fuse with a spare one.                             <ul style="list-style-type: none"> <li>AC power input (AC type only)</li> <li>Regulator circuit (AC and DC types)</li> <li>DC power cable (DC type)</li> </ul> </li> <li>Push [TIMER] OUT.</li> <li>Charge the battery.</li> </ul>	<p>p. 7</p> <p>p. 34</p> <p>p. 32</p>
<ul style="list-style-type: none"> <li>No sound comes from the speaker.</li> </ul>	<ul style="list-style-type: none"> <li>Volume level is too low.</li> <li>The squelch is closed.</li> <li>An external speaker or headphones are connected.</li> </ul>	<ul style="list-style-type: none"> <li>Rotate [AF GAIN] clockwise to obtain a suitable listening level.</li> <li>Rotate [SQUELCH] counter-clockwise to open the squelch.</li> <li>Disconnect the external speaker or headphones.</li> </ul>	<p>p. 13</p> <p>—</p>
<ul style="list-style-type: none"> <li>Sensitivity is low.</li> </ul>	<ul style="list-style-type: none"> <li>The coaxial cable is cut.</li> <li>The connected antenna is not matched to the receive frequency.</li> <li>No antenna is connected.</li> <li>The RF attenuator is activated.</li> </ul>	<ul style="list-style-type: none"> <li>Fix the coaxial cable.</li> <li>Connect an antenna matched to the receiving frequency.</li> <li>Connect an antenna.</li> <li>Push [ATT] to cancel the function.</li> </ul>	<p>—</p> <p>p. 7</p> <p>p. 7</p> <p>p. 14</p>
<ul style="list-style-type: none"> <li>Receive signal is distorted with strong signals.</li> </ul>	<ul style="list-style-type: none"> <li>The noise blanker function is activated in SSB or AM mode.</li> <li>The wrong mode switch is pushed.</li> </ul>	<ul style="list-style-type: none"> <li>Push [NB•AFC] to cancel the function.</li> <li>Push the correct mode switch.</li> </ul>	<p>p. 14</p> <p>p. 14</p>
<ul style="list-style-type: none"> <li>The displayed frequency does not change properly.</li> </ul>	<ul style="list-style-type: none"> <li>The dial lock function is activated.</li> <li>The AFC function is activated in WFM or FM mode.</li> <li>The internal CPU has malfunctioned.</li> </ul>	<ul style="list-style-type: none"> <li>Push [LOCK] to cancel the function.</li> <li>Push [NB•AFC] to cancel the function.</li> <li>Turn the power OFF. While pushing [MW] turn the power ON to reset the CPU.</li> </ul>	<p>p. 14</p> <p>p. 14</p> <p>p. 34</p>
<ul style="list-style-type: none"> <li>Scan does not operate properly.</li> </ul>	<ul style="list-style-type: none"> <li>Scan edges are set improperly for programmed or auto memory write scan.</li> <li>No memory channels are not designated select-number for memory scan.</li> </ul>	<ul style="list-style-type: none"> <li>Reset the appropriate pair of scan edges.</li> <li>Program select-number properly or select all-memory scan.</li> </ul>	<p>p. 23</p> <p>p. 23</p>
<ul style="list-style-type: none"> <li>Scan does not stop even when receiving strong signals.</li> </ul>	<ul style="list-style-type: none"> <li>The skip function is activated.</li> </ul>	<ul style="list-style-type: none"> <li>Push [SKIP] to cancel the function.</li> </ul>	<p>p. 21</p>
<ul style="list-style-type: none"> <li>Scan stops even when receiving no signal.</li> </ul>	<ul style="list-style-type: none"> <li>[SQUELCH] is set to an incorrect position.</li> </ul>	<ul style="list-style-type: none"> <li>Threshold differs depending on the receive mode. Adjust [SQUELCH] when scanning with more than 2 modes.</li> </ul>	<p>p. 14</p>
<ul style="list-style-type: none"> <li>All programmed memories are erased.</li> </ul>	<ul style="list-style-type: none"> <li>The memory backup battery is exhausted.</li> </ul>	<ul style="list-style-type: none"> <li>Replace the backup battery.</li> </ul>	<p>p. 35</p>
<ul style="list-style-type: none"> <li>Timer does not operate.</li> </ul>	<ul style="list-style-type: none"> <li>[TIMER] is not pushed IN.</li> </ul>	<ul style="list-style-type: none"> <li>Push [TIMER] IN.</li> </ul>	<p>p. 32</p>
<ul style="list-style-type: none"> <li>Clock cannot be set.</li> </ul>	<ul style="list-style-type: none"> <li>Timer is activated.</li> </ul>	<ul style="list-style-type: none"> <li>Push [TIMER] OUT.</li> </ul>	<p>p. 32</p>
<ul style="list-style-type: none"> <li>The clock time is incorrect.</li> </ul>	<ul style="list-style-type: none"> <li>The clock battery is exhausted.</li> </ul>	<ul style="list-style-type: none"> <li>Replace the backup battery.</li> </ul>	<p>p. 35</p>

# 8 OPTIONS INSTALLATION

## ■ UT-36 VOICE SYNTHESIZER UNIT

The UT-36 VOICE SYNTHESIZER UNIT announces the receiving frequency when [SPCH] is pushed.

- 1) Disconnect the AC power cable or AC adapter.
- 2) Remove the top cover. (p. 33)
- 3) Connect the 3-pin plug and 5-pin plug inside the IC-R7100 to the UT-36. (Fig. 1)

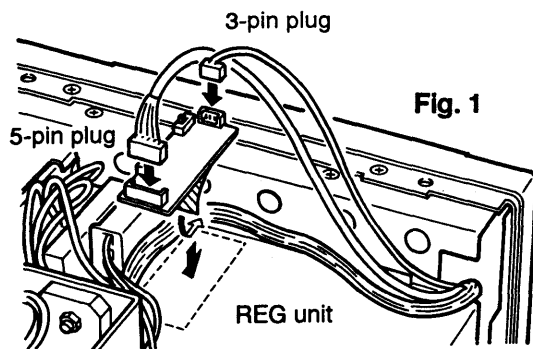

- 5) Attach the UT-36 to the REG unit. (Fig. 1)
- 6) Select speech language and speed. Adjust speech level. (Fig. 2)

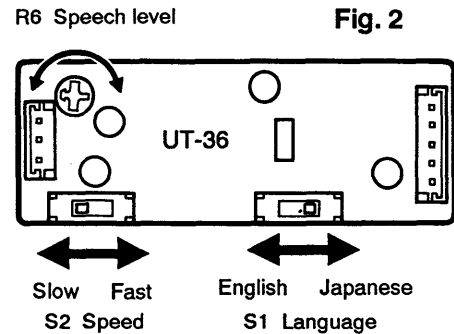

- 4) Remove the protective paper attached to the bottom of the UT-36 to expose the adhesive strip. (Fig. 1)

- 6) Replace the top cover.

## ■ MB-23 CARRYING HANDLE

The MB-23 CARRYING HANDLE allows you to transport the receiver easily.

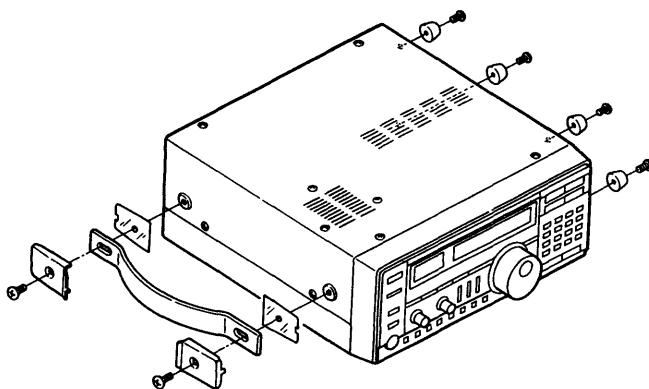

Using the screws supplied with the IC-R7100, attach the MB-23.

**NOTE:** The screws supplied with the MB-23 CANNOT be used with the IC-R7100.



## Under the top cover

**CONV UNIT**  
Converter for 1025-2000 MHz

Installation location for an optional UT-36 VOICE SYNTHESIZER UNIT

The photo at right shows the AC type.

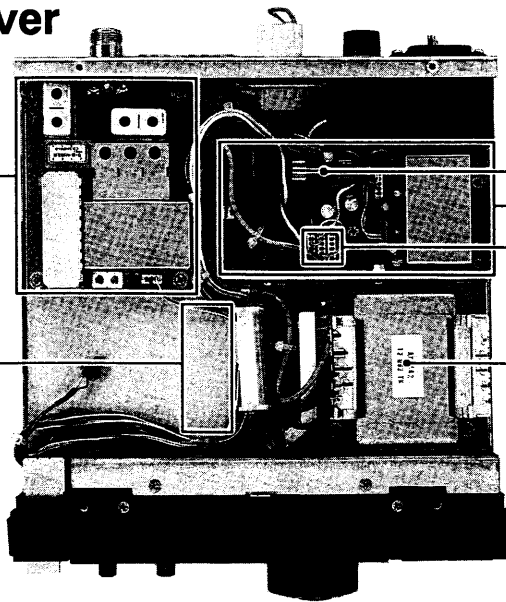

F5 Regulator circuit fuse  
REG UNIT  
J2 ~ J4 AC voltage modifications (except Germany version)

T1 transformer

## Under the REG unit

J23	Operation
	[AGC] outputs an AGC signal.
	[AGC] can be used as a spare jack.

W30 BFO frequency check point  
USB : 456.5 kHz by L14  
LSB : 453.5 kHz by C181

C181  
L14

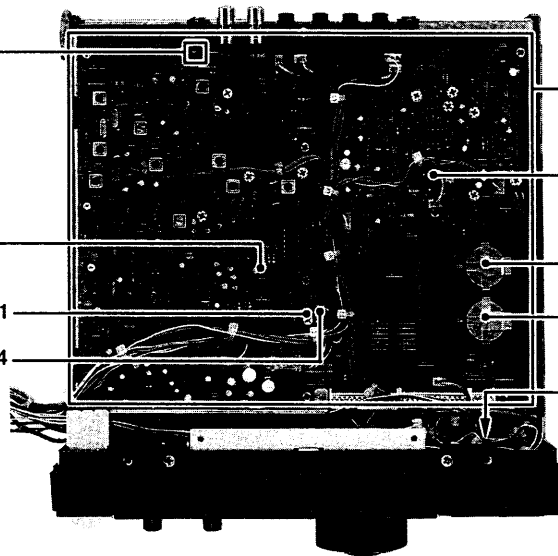

MAIN UNIT

R101 beep tone level adj. (p. 35)

BT1 lithium backup battery for clock (p. 35)

BT2 lithium backup battery for memories (p. 35)

Jumpers for CI-V condition setting (p. 10)

## Under the bottom cover

RF UNIT

- Frequency adjustment**
- 1) Set the receiver frequency to 511.9999 MHz in FM mode.
  - 2) Connect the frequency counter to J5.
  - 3) Rotate C69 to set the counter frequency to 768.0000 MHz.
  - 4) Reconnect the frequency counter to J4.
  - 5) Set the receiver frequency to 145.0000 MHz in FM mode.
  - 6) Rotate R35 to set the counter frequency to 923.7000 MHz.
  - 7) Rotate R41 to set the counter frequency to 923.6999 MHz when shifting the receiver frequency to 144.9999 MHz.

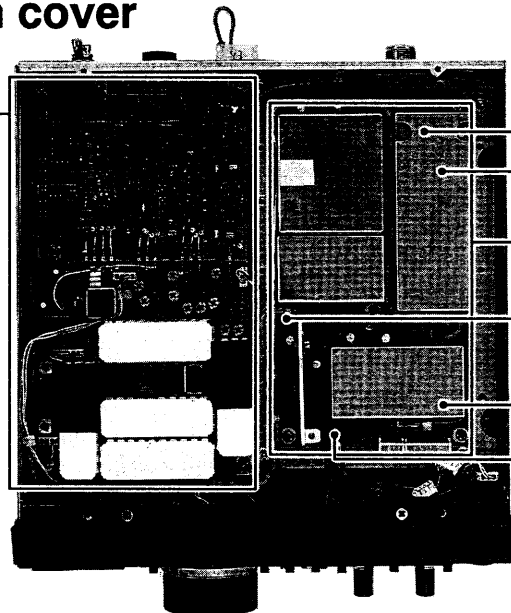

R41 1st Lo adj.

R35 1st Lo adj.

PLL UNIT

J4 1st Lo check point

C69 2nd Lo adj.

J5 2nd Lo check point

# 10 SPECIFICATIONS

• Frequency coverage :

Version	Frequency coverage
U.S.A.	25 ~ 1999.9999 MHz
U.S.A.-1	25 ~ 800, 900 ~ 1999.9999 MHz
Germany	28 ~ 29.7, 144 ~ 146, 430 ~ 440, 1240 ~ 1300 MHz
France	25 ~ 87.5, 108 ~ 1999.9999 MHz
Others	25 ~ 1999.9999 MHz

Specifications guaranteed 25 ~ 1000 MHz and 1240 ~ 1300 MHz.

• Mode :

SSB (LSB, USB), AM (Normal, Wide), WFM, FM (Normal, Narrow)

• Power supply requirement :

AC type 100, 117, 240 V AC (220 V AC only for Germany version)  
 DC type 16 V DC (AC adapter jack, 230 V AC for AC adapter)  
 AC and DC types 13.8 V DC  $\pm$  15% (DC power jack)

• Antenna impedances :

50  $\Omega$  (unbalanced)

• Current drain (13.8 V DC) :

Squelched 1.5 A Max. audio output 1.9 A

• Usable temperature range :

-10  $^{\circ}$ C ~ +60  $^{\circ}$ C (+14  $^{\circ}$ F ~ +140  $^{\circ}$ F)

• Frequency stability (in FM mode) :

25 ~ 250 MHz Less than  $\pm$  1.5 kHz  
 25 ~ 1000 MHz Less than  $\pm$  5 ppm  
 1240 ~ 1300 MHz Less than  $\pm$  10 ppm  
 ( 0  $^{\circ}$ C ~ +50  $^{\circ}$ C ;  
 +32  $^{\circ}$ F ~ +122  $^{\circ}$ F )

• Dimensions (projections not included) :

241(W)  $\times$  94(H)  $\times$  239(D) mm  
 9.5(W)  $\times$  3.7(H)  $\times$  9.4(D) in

• Weight :

AC type 6.0 kg; 13.2 lb DC type 4.9 kg; 10.8 lb

• Receive system :

SSB, AM, FM Triple-conversion superheterodyne  
 WFM Double-conversion superheterodyne

• Intermediate frequencies :

IF	25~512 MHz	512~1025 MHz
1st	778.700 MHz	266.700 MHz
2nd	10.700 MHz	10.700 MHz
3rd*	455 kHz	455 kHz

\*Except WFM

(Crystal converter system is adopted above 1025 MHz.)

• Sensitivity (typical) :

SSB Less than 0.2  $\mu$ V for 10 dB S/N  
 AM Less than 1.6  $\mu$ V for 10 dB S/N  
 WFM Less than 1.0  $\mu$ V for 12 dB SINAD  
 FM Less than 0.35  $\mu$ V for 12 dB SINAD

• Squelch sensitivity (threshold) :

AM, FM Less than 0.35  $\mu$ V  
 SSB, WFM Less than 4.5  $\mu$ V (WFM: 6  $\mu$ V at 1240~1300 MHz)

• Selectivity :

SSB More than 2.4 kHz/-6 dB  
 AM, FM-N More than 6.0 kHz/-6 dB  
 WFM More than 150 kHz/-6 dB  
 FM, AM-W More than 15 kHz/-6 dB

• Spurious rejection :

More than 50 dB

• Audio output power :

More than 2.0 W\* at 10% distortion with an 8  $\Omega$  load  
 \*More than 1.0 W in FM narrow mode.

All stated specifications are subject to change without notice or obligation.

## AH-7000 SUPER WIDEBAND OMNIDIRECTIONAL ANTENNA

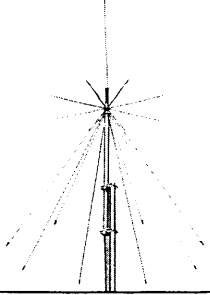

Frequency coverage:  
 - Receive 25~1300 MHz  
 - Transmit 50, 144, 430,  
 900, 1200 MHz  
 bands  
 Type of antenna : Discone  
 Weight : 1 kg

## SP-7 EXTERNAL SPEAKER

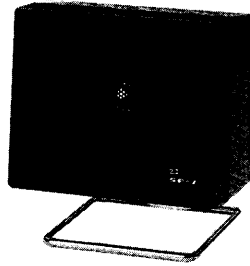

Size and style match the IC-R7100.  
 Input impedance : 8  $\Omega$   
 Max. input power : 5 W

## IC-SP3 EXTERNAL SPEAKER

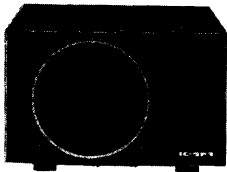

Input impedance : 8  $\Omega$   
 Max. input power : 4 W

## SP-20 EXTERNAL SPEAKER WITH AUDIO FILTER

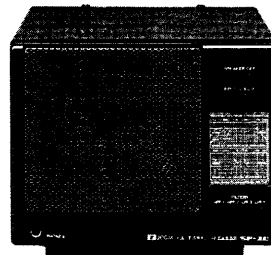

An external speaker with audio filters. Received audio quality can be changed with filters.

Input impedance : 8  $\Omega$   
 Max. input power : 5 W

## TV-R7100 TV RECEIVE ADAPTER

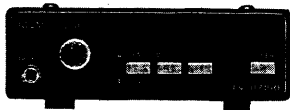

Allows TV broadcast reception and use of your TV set and video recorder. Also allows FM stereo broadcast reception.

## CT-17 CI-V LEVEL CONVERTER



For remote receiver control using a personal computer equipped with an RS-232C port. You can change operating frequencies, memory channels, etc., with your computer.

## MB-23 CARRYING HANDLE

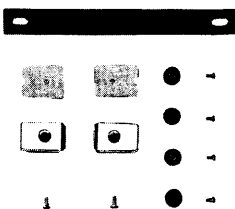

Carrying handle for easy portable operation.

## IC-MB5 MOBILE MOUNTING BRACKET

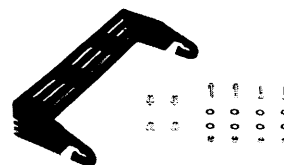

Receiver mounting bracket for mobile operation.

## UT-36 VOICE SYNTHESIZER UNIT

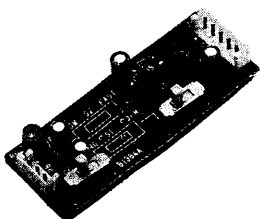

Announces the displayed frequency in English or Japanese. 2 speech speeds are available.

## AD-55 AC ADAPTER

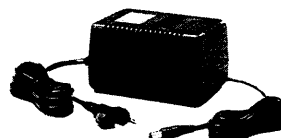

For the IC-R7100 DC type only. Allows you AC operation.

Input : 230 V AC  
 50 Hz  
 Output : 16 V DC  
 Max. 1.5 A

**Count on us!**

